



User Manual of Storage Lithium Battery

A5120



Manual Instruction

The Energy Storage Batteries System provides the energy storage for PV users and backup power support for the important electrical equipment. The battery system can store excessive power generated by PV system at daytime, and can utilize the stored energy (if necessary) to supply power for electrical equipment at night, thus improving the utilization efficiency of photovoltaic power generation, shaving peaks and filling valleys, providing backup power for emergency and important electrical equipment to avoid data and financial loss caused by sudden power outage.

The user manual introduces battery details like the basic structure, parameters, procedures and methods of installation, operation and maintenance.

This manual is only for the **51.2V 100Ah** Rack Mounted Lithium Battery, but the inverter and any other equipment is not included.

This PRODUCT can be installed in parallel mode, more attention should be paid for the DIP and address selection.

CONTENTS

1. Security Disclaimer	1
2. Precautions for Safe Use	1
3. Product Introduction	4
4. Specification	6
5. Installation	11
6. Abnormal Conditions and Fault Handling	16
7. Operation	17
8. Maintenance and Recycling	18
9. Legal statement	20

1. Security Disclaimer

Users must read this chapter carefully and operate it according to the safety precautions required by this chapter before installing, using and repairing the battery. Our company will be responsible for nothing if it happens to any injuries and loses caused by improper operations.

Attention
It may cause moderate injury or minor injury to human beings, or even damages to product because of the danger caused by failure to operate as requirements.
Danger
It may cause fire or serious personal injury, or even death because of the danger caused by failure to operate as requirements.

2. Precautions for Safe Use

We feel quite thankful that you choose **AMENSOLAR** products. In order to enable you to use and maintain it in a better way, please kind read this user manual carefully before use.

2.1 Unpacking Examination

- Please don't install the battery if it is found damage or lack of parts. Otherwise, it may be malfunction.
- Please don't install battery and connect with supplier in time if the packing list doesn't same as that of the real one.

2.2 Installation

- The battery is suggested installing by skilled worker or electrician. A skilled worker is defined as a people who had been trained and qualified electrician or had all of the following skills and experience:
 - ✧ Knowledge of the functional principles and operation of on-grid Energy Storage systems.
 - ✧ Knowledge of the dangers and risks associated with installing and using electrical devices and acceptable mitigation methods.
 - ✧ Knowledge of the installation of electrical devices
 - ✧ Knowledge of and adherence to this manual and all safety precautions and best practices.
- Please ensure that the power is cut off before wiring, otherwise, there will be a danger of electric shock or catching fire.
- The installed cables must be meet requirements, and the part of power distribution must comply with safety regulations.
- Please carry out the installation strictly in accordance with the installation steps in the following chapters, otherwise it will cause the damage to product.

- Please lift and put it down gently to avoid hurting feet or damage to product during transportation and installation.
- Please keep battery away from the flammable objects and heat sources.
- Please don't drop any sundries into battery during installation. Otherwise, it may cause system error.

2.3 Working

- Please don't directly plug or unplug the DC input socket or other sockets like the terminal block socket, input socket and output socket to avoid the danger of electric shock.
- Please don't directly open the battery shell to avoid the danger of electric shock.
- Please ensure that the battery will be work within the allowable range before operating to avoid damage to product.
- Please ensure that the battery is fully charged and the power is cut off if it is not used for a long time, avoid to the electricity power is empty due to long-term standing.
- Please charge the battery regularly and disconnect the switch after the charging is completed if the product is not used for a long time.

2.4 Maintenance and Overhaul

- Please ensure to disconnect the DC input, DC output and switch before disassembling the shell, to avoid the danger of electric shock.
- Please don't touch directly the exposed parts of circuit to avoid the danger of electric shock, as there is still residual electricity inside the battery even after the shell is disassembled.
- Please ask the professional personnel to perform the maintenance and overhaul.
- Please don't disassemble the battery by yourself. Otherwise, it may cause product damage and personal injury.

2.5 Transportation

- Please avoid strong vibration, falling and bumping during transportation. Don't place the package upside down. Don't lose any accessories and user manual when unpacking package or transporting battery.
- Please be careful of your security and avoid hurting yourself in transportation.

2.6 Others

- Please don't modify the system by yourself to avoid happening serious accidents.
- Please immediately cut off the switch and input/output cables if it happens to abnormal conditions inside the system.

2.7 Response to Emergency Situations

The battery is designed with multiple safety strategies to prevent hazards resulting from failures. However, we cannot guarantee their absolute safety for uncertain situations.

2.7.1 Leaking batteries

If the battery pack leaks electrolyte, avoid contact with the leaking liquid or gas. Electrolyte is corrosive and contact may cause skin irritation and chemical burns. If one is exposed to the leaked substance, do these actions:

Inhalation: Evacuate the contaminated area, and seek medical attention immediately.

Eyes contact: Rinse eyes with flowing water for 15 minutes, and seek medical attention immediately.

Skin contact: Wash the affected area thoroughly with soap and water, and seek medical attention immediately.

Ingestion: Induce vomiting as soon as possible, and seek medical attention immediately.

2.7.2 Fire

In case of a fire, make sure that an ABC or carbon dioxide extinguisher is nearby and does not use water to extinguish the fire.

WARNING

The battery pack may catch fire when heated above 130°C.

If a fire breaks out where the battery is installed, do these actions:

1. Extinguish the fire before the battery catches fire.
2. If the battery has caught fire, do not try to extinguish the fire. Evacuate people immediately.

WARNING

If the battery catches fire, it will produce poisonous gases. Do not approach.

2.7.3 Wet battery

If the battery is wet or submerged in water, do not try to access it. Contact your distributor for technical assistance.

2.7.4 Damaged battery

If the battery damaged, please contact your distributor for help as soon as possible, because damaged battery is dangerous and must be handled with extreme caution. Damaged battery is not suit for use and may pose a danger to people or property. If the battery seems to be damaged, return it to your distributor.

CAUTION

Damaged battery might export electrolyte or flammable gas, so contact for advice and information immediately.

2.8 Scrap Battery

For scrap battery(-ies), please treat with local laws or regulations to recycle or scrap.

3. Product Introduction

AMENSOLAR A5120 battery is composed of lithium iron phosphate cells in series. The built-in BMS battery management system can manage and monitor battery information, including voltage, current and temperature. In addition, the BMS can also balance the charge and discharge of the battery to extend the cycle life. The battery pack adopts the scientific internal structure design, advanced battery production technology, with high specific energy and long life, safety and reliability, wide temperature range and other characteristics, is the ideal green energy storage power products.



Cabinet mount



Stacked mount

3.1 Support Large-capacity Energy Storage

Multiple batteries can be connected in parallel to enlarge capacity.

3.2 High Reliability System

Adopting high-performance processor and configuring a customized BMS protection board to guarantee the system can operate stably.

Monitoring battery conditions in real-time. Providing many functions like short circuit protection, reverse polarity protection, high voltage protection, low voltage protection, over-current protection in charge, over-current protection in discharge, overcharge protection, over-discharge protection, high temperature protection, low temperature protection, balance cells, etc.

3.3 Strong Communication Function

Configuring multiple communication interfaces: RS-485, CAN; Knowing battery working status at any time through the master computer.

Multiple cascades: Obtaining address automatically; Non-human operation.

3.4 Leading Advantages in Product

Supporting charge and discharge by large current, charging and discharging modular design, Small volume, Light weight, adopting multi-level energy consumption management, Operation and wiring on front panel, Easy to installation and maintenance; Excellent compatibility; Seamless connection between BMS and inverter; More convenient operation in one switch; Suitable for long-term cycles of charge-discharge.

3.5 Product features

- Lithium iron phosphate battery, the weight is reduced by 40% compared with the same specifications of lead-acid battery;
- 2U rack structure, it can be directly loaded into a 600*800mm standard network cabinet. It is easy to be installed with the characteristics of easy maintenance, flexibility and versatility.
- It is equipped with stacking pack accessories, which can be stacked without cabinets.
- Battery pack shell with insulation coating metal sheet metal;
- The power output and input terminal of the battery pack adopts a high-power quick-plug connector, which supports hot swap.
- The battery pack can be used in parallel with a maximum of 16 pieces and cannot be used in series.
- Low self-discharge, no memory effect, shallow charge and shallow discharge performance is better.

4. Specification

4.1 Battery Specification



ITEM	A5120
Battery Type	LiFePo4
Mount Type	Rack Mounted
Nominal Voltage (V)	51.2
Capacity (Ah)	100
Nominal Energy (KWh)	5.12
Operating Voltage (V)	44.8~57.6
Max Charge Current (A)	100
Charging Current (A)	50
Max Discharge Current (A)	100
Discharging Current (A)	50
Charging Temperature	0°C~+55°C
Discharging Temperature	-20°C~+55°C
Relative Humidity	5% - 95%
Dimension (L*W*H mm)	496*600*88
Weight (KG)	43±0.5
Communication	CAN, RS485
Enclosure Protection Rating	IP21
Cooling Type	Natural Cooling
Cycles Life	≥6000
Recommend DOD	90%
Design Life	20+ Years (25°C @77°F)
Safety Standard	UL1973/CE/IEC62619/UN38.3
Max Number of Parallel	16

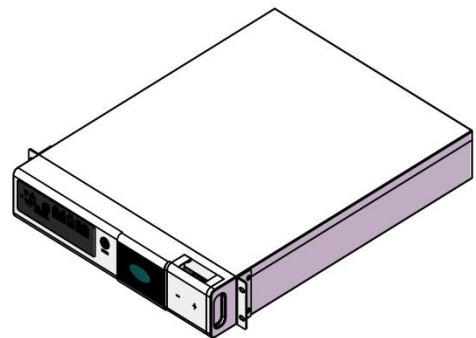
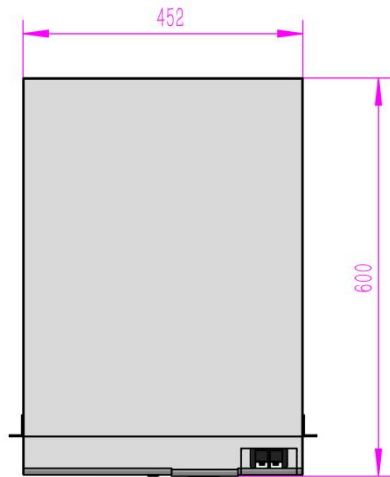
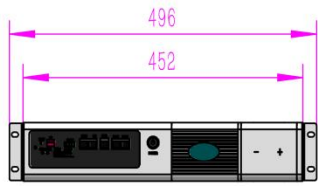

4.2 Product Size

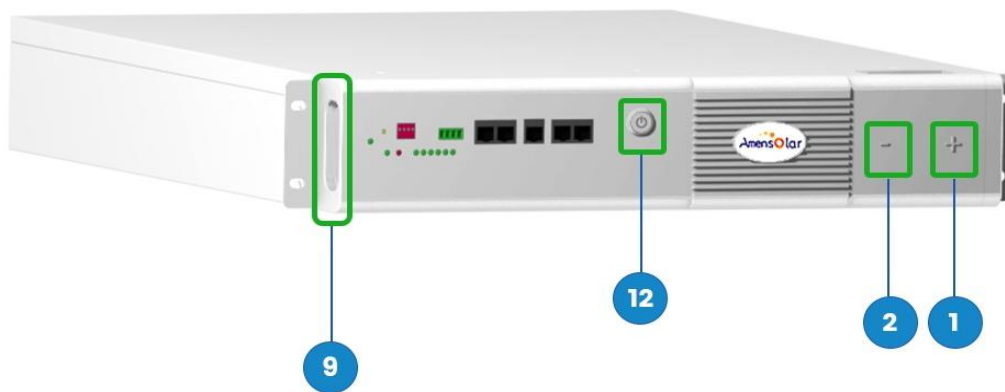
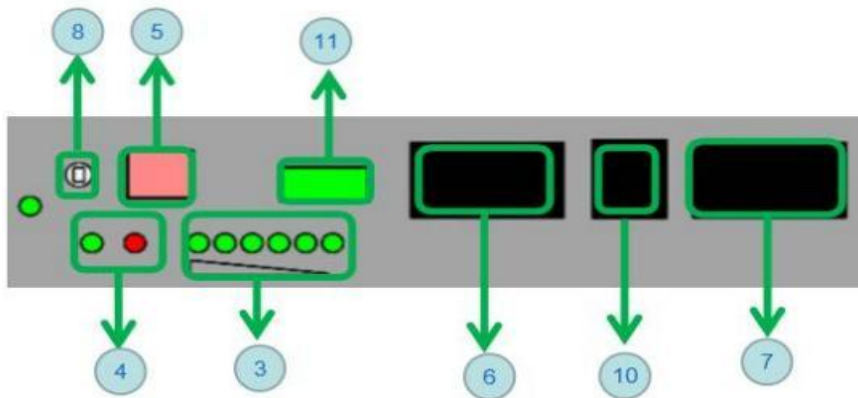

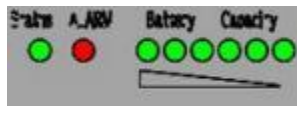
4.3 Product Panel Description

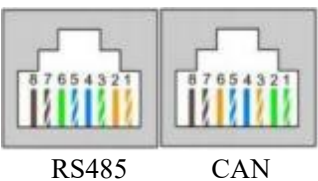

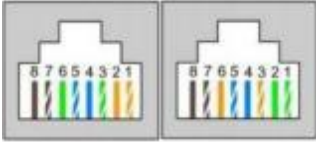
NO.	ITEM	FUNCTION	DESCRIPTION
1	Positive terminal	positive output/input connecting	MAX.DC125A(red) 2 sets can be used in parallel
2	Negative terminal	negative output/input connecting	MAX.DC125A(black) 2 sets can be used in parallel
3	Power indicator		SOC1: Green, remaining power indicator 1; 0~ 16.6%; SOC2: green, remaining power indicator 2; 16.6~33.2%; SOC3: green, remaining power indicator 3; 33.2~49.8%; SOC4: green, remaining power indicator 4; 49.8~66.4%; SOC5: green, remaining power indicator 5; 66.4~83.0%; SOC6: green, remaining power indicator 6; 83.0~100% ALM: red, alarm protection indicator;Blinking, steady on protection; RUN: Green, running indicator.
4	ALM/ RUN indicator		
5	Dip Switch Address		The dip switch has a total of 4 bits, 1, 2, 3, 4, each bit represents a value, all pushed to the digit, digit is 0, dialed to the ON bit represents 1, 2, 4, 8 in turn, dialed to the ON bit values added, and then +1 to get the address bit. (1+2+4=11+1=12.The 16th digit is: 1+2+3+4=15+1=16) For details, please refer to the attachment
6	CAN/RS485		RJ45 socket, pin definition and wiring requirements are as follows: RS485 interface: Pin1 & Pin8:485B Pin2 & Pin7:485A Pin3 & Pin6: GND CAN interface: Pin4: CAN_H [CAN Communication H] Pin5: CAN_L [CAN Communication L] Note: Wire specification 24AWG (0.2mm ²), wire length please choose according to the actual installation situation.

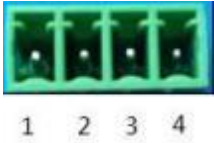
7	RS485/RS485	<p>Parallel communication The two interfaces can be connected in parallel</p> 	<p>RJ45 socket, pin definition and wiring requirements are as follows: Pin1 & Pin8: 485B Pin2 & Pin7: 485A Pin3 & Pin6: GND Pin5 & Pin4: NC Note: Wire specification 24AWG(0.2mm²), wire length please choose according to the actual installation situation.</p>
8	Reset	<p>Integrated with 3 functions of turn on, turn off and reset</p>	<p>When BMS is in hibernation state, press the key (3~6S) and release, and BMS is activated. When BMS is in the activated state, press the key (3~6S) and release, and BMS is hibernated. When BMS is activated, press the key (6~10S) and release, and BMS is reset.</p>
9	Handle	<p>handle</p>	
10	RS232	<p>PC side upper computer communication</p> 	<p>RJ11 socket, pin definition and wiring requirements are as follows: Pin3: TX Pin4: RX Pin5: GND Note: Wire specification 24AWG(0.2mm²), wire length please choose according to the actual installation situation.</p>
11	Dry contact		<p>optional</p>
12	POWER on/off	<p>Battery start button</p>	<p>Self-locking switch, switch pressed to open, switch flicked to close.</p>

4.4 Battery Management System (BMS protection board) Function

4.4.1 BMS Introduction

- ARM low power processor;
- Professional battery management chip;
- Support current-limiting charging mode (maximum 20A) ;
- Support CAN/RS485 communication;
- Built-in 4-channel temperature acquisition;
- Support high and low temperature overcharge and over-discharge protection;
- Support battery balancing function;

- Support SOC calculation and calibration;
- Support two-stage over-current protection;
- Support output short-circuit protection;
- Support polarity reverse connection protection;
- Support data storage;
- Multiple automatic fault detection (sampling, MOS, battery failure).

4.4.2 Voltage Protection Function

Discharging low-voltage protection	Charging over-voltage protection
In discharging, the over-discharge protection will start and battery stops to supply electricity if the voltage of any single cell is lower than the protection value. The protection will be dismissed after the voltage of all cells returns to the range of rated hysteresis value.	In charging, the system will stop charging if the voltage of battery module or any single cell reaches to the protection value. The protection will be dismissed after the battery module voltage and cell voltage return to the range of rated hysteresis value.

4.4.3 Current Protection Function

Charging over-current protection	Discharging over-current protection
System stops charging if charging current is over the protection value. Protection is dismissed after a period of time. Please pay attention that the maximum charging current shouldn't exceed to the protection value when using the battery.	System stops discharging if discharging current is over the protection value. Protection is dismissed after a period of time. Please pay attention that the current required by electrical equipment shouldn't exceed to the protection value when using the battery.

4.4.4 Temperature Protection Function

Charging low/over-temperature protection	Discharging low/over-temperature protection
In charging, system starts charging temperature protection and stops charging if the battery temperature is over protection range, and dismisses protection after temperature returns to rated hysteresis value.	In discharging, system starts discharging temperature protection and stops supplying electricity if the battery temperature is over the protection range, and dismisses protection after temperature returns to rated hysteresis value.

4.4.5 Other Protection Function

Short circuit protection
System starts short circuit protection if it occurs to short circuit when battery starts working from a shutdown state.

4.5 Running Environment

Running Environment	Condition
Working temperature	0°C - 50 °C
Relative humidity	5% - 95%, no condensation
Altitude	2000m

On-site environment	Away from heat source, avoid direct sunlight, no corrosive gas, no explosive gas, non-destructive insulation gas, non-destructive insulation conductive dust.
----------------------------	---

4.6 Storage

Battery storage should comply with the following:

- 1) When the battery is stored, it should be stored in the charged state of 40%~60%.
- 2) The battery should be stored in a clean, dry and ventilated room, avoid contact with corrosive substances, and stay away from fire and heat sources. In the storage process, it is prohibited to turn the battery upside down, and avoid mechanical impact and weight.
- 3) When the battery is not used for a long time, it is recommended to supplement the power every six months or so. It can be charged for 1 to 2 hours by using a DC voltage regulator charger by 0.2C current.
- 4) During maintenance, do not load or unload the battery cells in the battery by yourself; otherwise, the performance of the battery will be degraded.
- 5) Do not disassemble or change any battery cells in the battery without authorization, and do not dissect the battery.

5. Installation

5.1 Installation Location

Make sure that the installation location meets the following conditions:

- The building is designed to withstand earthquakes, and the floor is flat and level.
- Far away from the sea to avoid salt water and humidity.
- The installed location should not be access by pet and children.
- No flammable or explosive materials nearby, at least 2.5m far away from combustible.
- Minimal dust and dirt in the area.
- No corrosive gases present, including ammonia and acid vapor.

The battery optimal operate temperature is 15°C to 30°C. Frequent exposure to severe operating condition would exacerbate the performance and lifetime of the battery.

5.2 Installation Requirements

- The installation shall be in a restricted access location/ room or in a cabinet where provides a barriers for the battery terminal.
- The maximum number of battery shall be not over 16 PCS.

5.3 Installation Materials

Following installation materials should be prepared by installers.

- Power cable
- Data cable
- Earth cable

- Ground wire
- Bipolar external isolator, when two or more battery systems in parallel, each of them shall have a bipolar isolator. Meanwhile, the isolator shall have ability to break the full load current.

NOTICE

Make sure that the cross-sectional area of charging cables is 25 to 35 mm².

NOTICE

A breaker between battery and inverter was recommended to install, and the breaker's min. current should be over 150A or following with local regulations.

5.4 Tools

To install the battery pack, those following tools are probably required:



Phillips screwdriver



Torque wrench

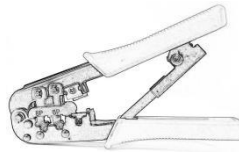

Cable crimper

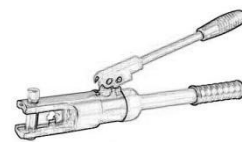

Wire clamp

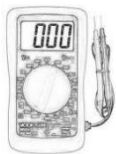

Voltmeter

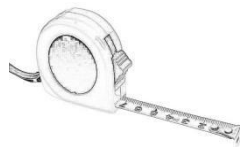

Tape measure

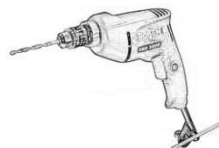

Drill

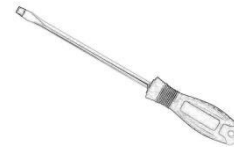

Flat-head screwdriver

- In order to protect operator and installer's safety, please select and use suitable tools and measuring instruments that are certified for precision and accuracy.

5.5 Safety Instruments

When dealing with the battery, following safety gears should be equipped. Installers must meet the relevant requirements of IEC 60364 or the domestic legislation and other relevant international standards.



Insulated glove

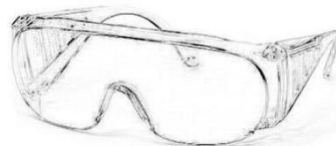

Safety goggles



Safety shoes

5.6 Technical Preparation

Electrical interface setting	Security examination
<p>Please kind do the following examination if the battery connects with the user's device directly:</p> <p>Check whether the DC charging interface of inverter meets requirements of specification, voltage, current of battery pack.</p> <p>Check whether power of electrical device matches with the parameters of battery pack.</p>	<p>Fire-fighting equipment should be prepared near the battery, like, the portable dry powder fire extinguisher. It is strictly forbidden to place flammable, explosive and other dangerous items next to the battery.</p>

5.7 Unpacking

Please unload the product as requirements and prevent it from sun and rain when the device arrives at installing site. Before unpacking, please check the total number of materials in Packing List attached on package, and check whether is package is well packed or not.

In the process of unpacking, please pay attention to lift and put it down gently and protect its surface coating.

The installing person should read technical document, check the list, confirm whether accessories are completed and intact according to Packing List at first after unpacking. If internal packages are damaged, please check it carefully and take records.

5.8 Preparation

- Please ensure the POWER buttons of all batteries are in cut-off status.
- Please ensure the charging voltage of the device is within the product allowable range.
- Please cut off power to all related devices.

5.9 Installation and wiring

5.9.1 Device installation

Please take reference of the way recommended by manual to place the product. All devices must be firm during installation. Please arrange the stacked number of devices flexibly as actual needs. Don't install batteries on sloping and unstable ground.

5.9.2 Ground wire connection

Please unscrew the screw at the ground hole on front panel, install the ground terminal on the screw and tighten it with a screwdriver. The other end of ground wire is connected to the nearby bracket, and the whole is connected to a reliable ground point.

5.9.3 Power cable connection

Please check the continuity of the cable, distinguish the positive and negative terminals, and label the cables before connecting power cable. Please also check whether there is short circuit and reverse connection after the cable connection is finished. The checking method is as follows:

Cable continuity: please adjust to the buzzer gear of multimeter and test two ends of the cable by a probe. If the buzzer sounds, the cable is available.

Voltage diagnosis: please adjust to the DC voltage gear of multimeter and test the positive and negative electrode of battery by a probe. If it indicates the voltage within the normal range, the product can be used.

5.9.4 Cables connection

A single battery: please connect the positive electrode of battery with the DC positive electrode of inverter by a red cable, and connect the negative electrode of battery with the DC negative electrode of inverter with a black cable.

Multiple batteries: please adopt the parallel connection method between battery and battery or battery and inverter. At first, please connect the positive terminals of the adjacent 2 batteries respectively by a red cable, and connect the negative terminals of the adjacent 2 batteries respectively by a black cable. Second, please connect the positive electrode of battery with the DC positive electrode of inverter by a red cable, and connect the negative electrode of battery with the DC negative electrode of inverter by a black cable.

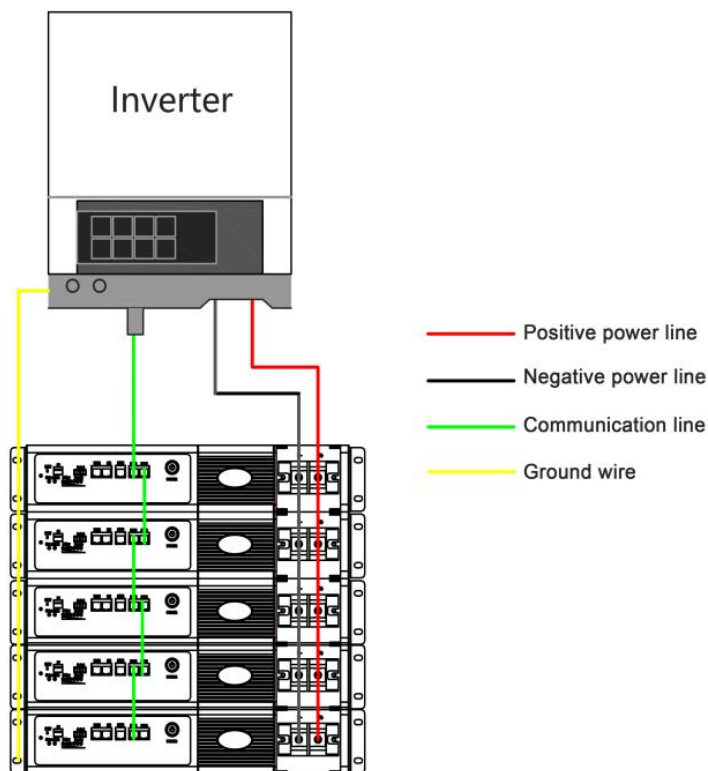

5.9.5 Communication wire connection

A single battery: just select the corresponding interface according to the communication protocol of inverter, or please connect the CAN interface of battery with the communication interface of inverter. The RS485 interface of battery is used for the communication connection of two batteries.

Multiple batteries: the host and the slave batteries communicate in cascade mode, one of them is the host, and the rest are slave batteries. Then, the corresponding port can be connected to the host battery according to the communication protocol of inverter.

5.9.6 Start-up

- Please confirm again whether all cables are correctly connected, firmly connected, and not short circuit or reverse connection before starting up.
- Please turn all battery switch buttons to “ON” .
- A single battery: If the battery SOC indicator is always on and the alarm indicator is off, it means that the battery has been started.
- Multiple batteries: If all battery SOC indicators are always on and the alarm indicator is off, it means that all batteries have been started.
- Attention: please connect the inverter immediately to charge if battery power is too low and cannot be started.

5.9.7 Power-on test

- Please connect battery and inverter or DC switching power supply.
- Please check whether battery state is normal according to the indicator table:
 - ✧ battery will be in charging mode if battery power is not full and inverter has successfully charged to battery.
 - ✧ battery will be in standby mode if battery power is full and is not supply power to loads.
 - ✧ battery will be in discharging mode if battery is supply power to loads.

STATUS	Normal Alarm Protection	ON/OFF	RUN	ALM	POWER INDICATOR LED						DESCRIPTION	
		●	●	●	●	●	●	●	●	●		
TURN OFF	Sleep	OFF	OFF	OFF	OFF	OFF	OFF	OFF	OFF	OFF	OFF	ALL OFF
STANDBY	Normal	ON	FLASH1	OFF	According to power indicator						STANDBY	
	Alarm	ON	FLASH1	FLASH3	According to power indicator						Low voltage	
CHARGE	Normal	ON	ON	OFF	According to power indicator (Maximum power LED of power indicator flash twice)						Maximum power LED flashing (flash twice). When overcharging alarm, ALM does not flash	
	Alarm	ON	ON	FLASH3	According to power indicator (Maximum power LED of power indicator flash twice)							
	Overcharge protection	ON	ON	OFF	ON	ON	ON	ON	ON	ON	ON	If no grid power, indicator switch to standby
	Protection for temperature over-current and failure	ON	OFF	ON	OFF	OFF	OFF	OFF	OFF	OFF	OFF	No Charging
DISCHARGE	Normal	ON	FLASH3	OFF	According to power indicator							
	Alarm	ON	FLASH3	FLASH3	According to power indicator							
	Low voltage protection	ON	OFF	OFF	OFF	OFF	OFF	OFF	OFF	OFF	OFF	Stop Discharging
	Temperature, over-current, short circuit, reverse connection, failure protection	ON	OFF	ON	OFF	OFF	OFF	OFF	OFF	OFF	OFF	Stop Discharging
FAILURE		OFF	OFF	ON	OFF	OFF	OFF	OFF	OFF	OFF	OFF	Stop Charging/Discharging

6. Abnormal Conditions and Fault Handling

6.1 Fault and abnormal phenomenon handling

Fault Phenomenon	Fault Causes	Handling Method
DC input fault	No DC input voltage	Please check whether DC input switch is closed, check whether circuit is open
Battery fault	No battery DC output	Please check whether switch is closed, check whether circuit is open
Overload	Too large power or short circuit	Please confirm whether load is less than the rated power, check whether load is short circuit
Abnormal temperature inside system	Over temperature inside box	Please turn off the load and restart it after temperature drops, check whether ambient temperature exceeds the standards
Low battery	SOC too low	Please charge the battery
System fault	System operation error	Please cut off load, shutdown switch, and restart battery

The battery is designed with indicators on the upper panel, and has perfect protection function. Battery system will stop to output power and indicators will indicate the abnormal condition once the abnormality or failure occurs.

7. Operation

7.1 Charging precautions

1) Charging current

The charging current must not exceed the maximum allowable charging current specified in this specification. Charging with abnormal current will cause the system protection to start, which may affect normal use.

2) Charging voltage

The charging voltage shall not exceed the maximum charging voltage specified in this specification. When the battery voltage is higher than the maximum charging voltage, it will cause the system protection to start, which may affect the normal use.

3) Charging temperature

The battery must be charged in the range of 0°C to 55°C.

4) Reverse charging is prohibited

The battery must be connected according to the installation instructions. Reverse charging is prohibited and short circuit is prohibited in the positive and negative electrodes of the battery to avoid the battery pack failure and damage.

7.2 Discharging precautions

1) Discharge current

The load and discharge current of the battery pack should be controlled reasonably. Excessive use will cause irreversible damage to the battery and affect the normal use.

2) Discharge voltage

Over-discharging of the battery pack will cause adverse internal chemical reactions, so as to affect the normal use, should try to avoid this situation. After the occurrence of over-discharge, the battery should be evaluated before continuing to use.

3) Discharge temperature

The product must be discharged in the range of -20°C~55°C, abnormal discharge temperature may affect the life of the product or make the system protection start, affecting the normal operation.

7.3 Others

In order to prevent leakage, heating and explosion of the battery, the following operations should be avoided:

- 1) Do not put the battery into the fire or heat it;

- 2) Do not break down or disassemble the battery;
- 3) It is strictly prohibited to immerse the battery in seawater or water. When not in use, it should be placed in a cool and dry environment;
- 4) Do not place the battery near high temperature sources, such as fire, heater, etc.;
- 5) It is strictly prohibited to connect AC directly, and the DC charger must be used to charge in accordance with the regulations;
- 6) It is strictly prohibited to use the battery by reversing the positive and negative electrodes;
- 7) Do not use metal to directly short circuit the positive and negative electrodes of the battery;
- 8) It is forbidden to store the battery together with metal, and insulation protection measures should be taken;
- 9) It is forbidden to use or place the battery at high temperature, otherwise it may cause overheating, function failure or life reduction of the battery;
- 10) Do not use the battery in places with strong static electricity and magnetic field, otherwise it will easily damage the battery safety protection device and bring safety risks.

8. Maintenance and Recycling

Frequent maintenance is required in order to ensure the continuous and normal operation of battery, and recycling of old equipment is also required in order to settle the environmental protection issues.

8.1 Operation environment

The installation and storage of battery should avoid the environment of high corrosiveness, high dust, high temperature and high humidity, especially avoid metal substances falling into the box.

8.2 Security examination

Please check regularly whether connecting line is aging, and whether connection point of cable is tight and safe.

8.3 Maintenance requirement

Please cut off power supply completely before opening the box for maintenance. Please don't damage parts and components when disassembling, and pay attention to the sequence of wiring. Please also perform maintenance by wearing insulting gloves and using insulting tools.

8.4 Specific requirements of maintenance

Please clean the dust and debris in box, and check whether the terminals and screws in box are fastened, whether traces left and damaged components by overheating in the box. Please refer to user manual to deal with problems when the battery is in fault and cannot work

normally. If the problem still cannot be solved, please contact with the dealer or the manufacturer as soon as possible. Don't disassemble parts by yourself.

8.5 Battery Recycling

About the information on proper disposal of old battery, please contact with your local recycling center or hazardous waste disposal center. Please don't discard battery into fire as it may lead to the danger of explosion. Please take reference for your local regulations about battery disposal requirements and dispose the wasted battery properly. Don't disassemble battery randomly as the released electrolyte is harmful to your skins and eyes, and it even has toxic. Please don't discard battery into trash. For more detailed information, please contact with your local recycling/reuse center or hazardous waste disposal center. Don't discard the wasted electrical or electronic devices into trash. Please contact your local recycling/reuse center for proper disposal;

Legal statement

The copyright of the manual belongs to **AMENSOLAR ESS CO., LTD.**. Any unit, company or individuals is not allowed to extract, copy and translate it in any way without the written permission of copyright owner. Otherwise, infringement must be investigated.

The user manual doesn't grant readers the permission and rights to use any marks showing in the manual in any method without the prior written agreement of **AMENSOLAR ESS CO., LTD.** or owner of manufacturer's trademark or trade name.

The product complies with the requirements of environmental protection and personal safety. The storage, use and disposal of product should be carried out in accordance with the product manual, relevant contracts or laws, regulations.

You can check relevant technical information through **AMENSOLAR ESS** website when there are product updates and technical changes.

Amensolar ESS Co., Ltd.

Web: www.amensolar.com

Add: No. 900, Zhujiang Road, SND, Suzhou City, Jiangsu Province, PRC

Tel: 0086-512-68243965