User Manual

SG125HV
SG125HV-20
PV Grid-connected
Inverter



About This Manual

This manual is for the SG125HV/SG125HV-20, a three-phase PV grid-connected transformerless inverter, (hereinafter referred to as inverter unless otherwise specified). The inverter is grid-connected, transformer-less, robust and of high conversion efficiency.

Aim

This manual contains information about the inverter, which will provide guidelines on connecting the inverter into the PV power system and how to operate the inverter.

Related Documents

The manual cannot include all information about the PV system. You may get additional information at www.sungrowpower.com.

Target Group

This manual is for technical personnel who are responsible for inverter installation, operation and maintenance, and the inverter owner who will perform daily APP operation.

How to Use This Manual

Read the manual and other related documents before commencing any work on the inverter. Documents must be stored carefully and available at all times.

All rights reserved including the pictures, markings and symbols used. Any reproduction or disclosure, even partially, of the contents of this manual is strictly prohibited without prior written authorization of Sungrow.

The contents of the manual will be periodically updated or revised due to product development. There may be changes in the manual due to subsequent inverter editions. The latest manual can be acquired via visiting the website at www.sungrowpower.com.

Symbols Explanation

Important instructions contained in this manual should be followed during installation, operation and maintenance of the inverter. They will be highlighted by the following symbols.

DANGER

DANGER indicates a hazard with a high level of risk which, if not avoided, will result in death or serious injury.

WARNING

WARNING indicates a hazard with a medium level of risk which, if not avoided, could result in death or serious injury.

CAUTION

CAUTION indicates a hazard with a low level of risk which, if not avoided, could result in minor or moderate injury.





NOTICE

NOTICE indicates a situation which, if not avoided, could result in equipment or property damage.



NOTE indicates additional information, emphasized contents or tips to help you solve problems or save time.

Symbols on the Inverter Body

	<p>WARNING: ELECTRIC SHOCK HAZARD. THE DC CONDUCTORS OF THIS PHOTOVOLTAIC SYSTEM ARE UNGROUNDED AND MAY BE ENERGIZED.</p> <p>WARNING: Electric Shock Hazard. The DC conductors of this photovoltaic system are normally ungrounded but will become intermittently grounded without indication when the inverter measures the PV array isolation.</p>
	<p>CAUTION: Risk of Electric Shock, Do Not Remove Cover. No User Serviceable Parts Inside. Refer Servicing To Qualified Service Personnel.</p> <p>CAUTION: Risk Of Electric Shock</p> <ul style="list-style-type: none">a) Both ac and dc voltage sources are terminated inside this equipment. Each circuit must be individually disconnected before servicing, andb) When the photovoltaic array is exposed to light, it supplies a dc voltage to this equipment.
	<p>CAUTION: Risk of electric shock from energy stored in capacitor. Do not remove cover until 5 minutes after disconnecting all sources of supply.</p>
	<p>CAUTION: Hot surfaces – To reduce the risk of burns. Do not touch.</p>
	<p>CAUTION: Check user manual before service!</p>

WARNING: ELECTRIC SHOCK HAZARD. THE DC CONDUCTORS OF THIS PHOTOVOLTAIC SYSTEM ARE UNGROUNDED AND MAY BE ENERGIZED.	AVERTISSEMENT: RISQUE DE CHOC ÉLECTRIQUE. LES CONDUCTEURS DC DE CE SYSTÈME PHOTOVOLTAÏQUE NE SONT PAS MIS À LA TERRE ET PEUVENT ÊTRE MIS SOUS TENSION.
WARNING: Electric Shock Hazard. The DC conductors of this photovoltaic system are normally ungrounded but will become intermittently grounded without indication when the inverter measures the PV array isolation.	AVERTISSEMENT: Risque de choc électrique. Normalement, les conducteurs CC de ce système photovoltaïque ne sont pas mis à la terre, mais seront mis à la terre sans indication lorsque l'onduleur mesure l'isolation du réseau photovoltaïque.
CAUTION: Risk of Electric Shock, Do Not Remove Cover. No User Serviceable Parts Inside. Refer Servicing To Qualified Service Personnel.	ATTENTION: risque de choc électrique, ne pas retirer la couverture. Pas de pièces pouvant être réparées par l'utilisateur à l'intérieur. Consulter le personnel qualifié de service.
CAUTION: Risk Of Electric Shock a) Both AC and DC voltage sources are terminated inside this equipment. Each circuit must be individually disconnected before servicing. b) When the photovoltaic array is exposed to light, it supplies a DC voltage to this equipment.	ATTENTION: Risque de choc électrique A) Les sources de tension AC et DC sont terminées à l'intérieur de cet équipement. Chaque circuit doit être déconnecté individuellement avant l'entretien, et B) Lorsque le réseau photovoltaïque est exposé à la lumière, il fournit une tension DC à cet équipement.
CAUTION: Risk of electric shock from energy stored in capacitor. Do not remove cover until 5 minutes after disconnecting all sources of supply.	ATTENTION: risque de choc électrique par l'énergie stockée dans le condensateur. Ne pas retirer le couvercle jusqu'à 5 minutes après avoir débranché toutes les sources d'alimentation.
CAUTION: Hot surfaces – To reduce the risk of burns. Do not touch.	ATTENTION: surface chaude - Pour réduire le risque de brûlure. Ne pas le toucher.

CAUTION: Check user manual before service.

ATTENTION: Vérifier le manuel d'utilisateur avant l'utilisation.

Contents

About This Manual	I
1 Safety Instructions.....	1
2 Product Description.....	13
2.1 Intended Usage	13
2.2 Product Introduction	14
2.2.1 Model Description.....	14
2.2.2 Appearance	15
2.2.3 Dimensions.....	16
2.2.4 LED Indicator Panel	16
2.2.5 DC Switch	17
2.2.6 AC Switch.....	18
2.3 Technical Description	18
2.3.1 Circuit Diagram.....	18
2.3.2 Function Description	19
2.3.3 Derating	20
2.3.4 PID Function.....	23
3 Installation Flow	24
4 Unpacking and Storage.....	26
4.1 Unpacking and Inspection.....	26
4.2 Identifying Inverter	27
4.3 Scope of Delivery.....	28
4.4 Inverter Storage.....	29
5 Mechanical Installation	31
5.1 Installation Site Selection	31
5.2 Moving Inverter to Installation Site	34

5.3	Installation Tools	35
5.4	Installing the Inverter	35
5.4.1	Installing to Metal Frame	36
5.4.2	Installing to Concrete Wall.....	38
6	Electrical Connection.....	41
6.1	Terminal Description.....	41
6.1.1	Appearance	41
6.1.2	Dimensions of Terminal.....	43
6.2	AC Side Cable Connection.....	45
6.2.1	AC side requirements.....	45
6.2.2	Grid Connection	48
6.3	Connecting Inverter to PV Arrays	52
6.3.1	PV Input Configuration	52
6.3.2	PV Input Connection	53
6.4	Grounding the Inverter	57
6.4.1	Grounding System Overview	57
6.4.2	Second Protective Earth Terminal.....	58
6.5	RS485 Communication Connection.....	59
6.5.1	Communication Overview	59
6.5.2	RS485 Communication System.....	60
6.5.3	RS485 Communication Connection.....	62
6.6	Configurable Dry Contact	64
7	Commissioning	66
7.1	Inspection before Commissioning.....	66
7.2	Commissioning Procedure.....	66
8	Disconnecting, Dismantling and Disposing the Inverter	68
8.1	Disconnecting the Inverter	68
8.2	Dismantling the Inverter.....	68
8.3	Disposal of the Inverter.....	69

9	Troubleshooting and Maintenance	70
9.1	Troubleshooting	70
9.2	Maintenance	79
9.2.1	Routine Maintenance	79
9.2.2	Maintenance Instruction	79
10	SunAccess APP	82
10.1	Introduction to the System	82
10.2	Acquire and install SunAccess APP	82
10.2.1	Installation Condition	82
10.2.2	Operation Steps	82
10.3	Log into SunAccess APP	83
10.4	Homepage	86
10.5	Run Info	88
10.6	History Record	90
10.6.1	Fault Alarm Records	90
10.6.2	Power Yields Records	92
10.6.3	Event Records	93
10.7	More	94
10.7.1	Power On/Power Off	95
10.7.2	System Parameters	96
10.7.3	Operation Parameters	97
10.7.4	Protection Parameters	99
10.7.5	Communication Parameters	102
10.7.6	Download the Log	103
10.7.7	About SunAccess	104
11	Appendix	105
11.1	Technical Data	105
11.2	Tightening Torques	106
11.3	Exclusion of Liability	107

11.4 Contact Information109

1 Safety Instructions

The inverter has been designed and tested according to strict international safety regulations. As electrical and electronic equipment, safety instructions related to them must be complied with during installation, commissioning, operation and maintenance. Incorrect operation or work may result in damage to:

- The property safety of the operator or a third party
- The inverter and other properties that belong to the operator or a third party

Therefore, the following general safety instructions must be read and always kept in mind prior to any work. All detailed work-related safety warnings and notes will be specified at the critical points in corresponding chapters.

WARNING

All installations should be performed by technical personnel. They should have:

- **Received professional training;**
- **Read through this manual and understood all related safety instructions;**
- **Been familiar with electric system related safety instructions.**

Technical personnel mentioned above may perform the following work:

- Install the inverter in a proper place;
- Connect the inverter to the PV system;
- Connect other devices to the PV system;
- Commission the inverter;
- Operate and maintain the inverter.

Before Installation

NOTICE

The unit is thoroughly tested and strictly inspected before delivery. Damage may still occur during shipping.

If there is visible damage to the packaging or the inner contents, or if there is something missing, contact Sungrow or the forwarding company.

 CAUTION

There is a risk of injury due to improperly handling the device!

- **Always follow the instructions in the manual when moving and positioning the inverter.**
- **Injuries, serious wounds, or bruises may occur if the device is improperly handled.**

During Mechanical Installation

 DANGER

Make sure inverter is not electrically connected before installing the inverter.

 CAUTION

System performance loss due to bad ventilation!

Proper-ventilation should be maintained during device operation. The fan's air inlet and outlet should not be covered to ensure the device interior can sufficiently cool down.

During Electrical Connection

NOTICE

All electrical connections must be in accordance with national and local standards.

The connection to the grid can be done only after receiving approval from the local utility grid company.

 DANGER

Lethal voltage exists!

PV arrays will generate electrical energy when exposed to sunlight and thus can create potential electrical shock hazards.

 **WARNING**

All cables must be firmly attached, undamaged, properly insulated and adequately dimensioned.

During Inverter Operation

 **WARNING**

Do not open inverter enclosure when inverter is under load or operating.

Only an intact and locked inverter cabinet can ensure personal and property safety.

 **CAUTION**

There is a risk of burn!

Do not touch hot components of the inverter (for example, the heatsink) during operation. Only the DC/AC switch can be touched during operation.

Operate the inverter by strictly following the descriptions in this manual to avoid unnecessary personal injury and property damage. Arc flash, fire or explosion may occur if done otherwise and Sungrow will hold no liability for damages.

 **WARNING**

The following improper operations can cause an arc flash, fire and explosion inside the device. Keep in mind that these accidents can only be handled by qualified personnel. Improper handling of these accidents may lead to a more serious fault or accident.

- **Plugging in and unplugging the DC side HV fuse when it is alive;**
- **Touching the end of the cables that have no insulation and may still be alive;**
- **Touching the connection copper bus bar, terminal or other spare parts**

inside the device that may be alive;

- The power cable connection is loose;
- Spare parts, such as bolts, are falling inside the inverter;
- Incorrect operation by unqualified persons that have not received training;

WARNING

Before any operation of the device, a preliminary arc flash assessment in the operation area is necessary. If there is a possibility of an arc flash,

- The operators must receive related safety training;
- Use best practices to assess the areas that may be affected by an arc flash ;
- Before any operation in the area that may be affected by an arc flash, personal protective equipment (PPE) that meets the requirement must be worn. A PPE category 2 is recommended.

Maintenance and Service

DANGER

There is a risk of inverter damage or personal injury due to incorrect service work!

- Before any operation, you should perform the following steps:
- First, disconnect the grid side switch and then disconnect the DC switch;
- Wait at least 10 minutes until the inner capacitors are discharged completely;
- Verify, using proper testing device to make sure there is no voltage or current.

CAUTION

Keep unqualified persons away!

A temporary warning sign and barrier must be posted to keep unqualified persons away during electrical connection and

maintenance.

NOTICE

- **Restart the inverter only when the fault that may impair the inverter safety functions is removed.**
- **Inverter contains no owner serviceable parts inside. Please contact local authorized personnel if any service work is required.**

NOTICE

Do not replace the inverter internal components without permission. Damage to the inverter may occur and it may void any or all warranty rights from Sungrow.

NOTICE

- There is a risk of inverter damage due to electrostatic discharge!**
- The printed circuit boards contain components sensitive to electrostatic discharge.**
- **Wear a grounding wrist band when handling the boards.**
 - **Avoid unnecessary touching of the boards.**

Others

NOTICE

Certain parameter settings (country selection, etc.) by the SunAccess APP must only be done by qualified persons.

Incorrect country setting may affect the inverter normal operation and cause a breach of the type-certificate marking.

WARNING

- All safety instructions, warning labels, and nameplate on the inverter:**
- **Must be clearly visible;**
 - **Should not be removed or covered.**

⚠ WARNING

Respect the following regulations:

- **Grid-connection regulations;**
- **Safety instructions related to PV arrays;**
- **Safety instructions related to other electrical devices.**

Consignes de Sécurité

L'onduleur a été conçu et testé selon les règles de sécurité internationales strictes. En tant qu'équipement électrique et électronique, les consignes de sécurité qui s'y rapportent doivent être respectées lors de l'installation, de la mise en service, de l'utilisation et de la maintenance. Un fonctionnement ou un travail incorrect peut endommager:

- La vie et le bien-être de l'opérateur ou d'un tiers
- L'onduleur et d'autres propriétés qui appartiennent à l'opérateur ou à un tiers

Par conséquent, les consignes de sécurité générales suivantes doivent être lues et toujours gardées en tête avant tout travail. Tous les avertissements et notes de sécurité détaillés liés au travail seront spécifiés aux points critiques des chapitres correspondants.

AVERTISSEMENT

Toutes les installations doivent être effectuées par du personnel technique. Ils devraient avoir:

- **Reçu une formation professionnelle;**
- **Lu ce manuel et compris toutes les consignes de sécurité connexes;**
- **Connu les consignes de sécurité liées au système électrique.**

Le personnel technique mentionné ci-dessus peut effectuer les travaux suivants:

- Installer l'onduleur dans un endroit approprié;
- Connecter l'onduleur au système photovoltaïque;
- Connecter d'autres appareils au système photovoltaïque;
- Mettre l'onduleur en service;
- Faire fonctionner et maintenir l'onduleur.

Avant l'Installation

NOTICE

L'appareil est soigneusement testé et strictement inspecté avant la livraison. Des dégâts peuvent survenir lors de l'expédition.

S'il y a des dommages visibles à l'emballage ou au contenu interne, ou s'il y a quelque chose qui manque, contacter Sungrow ou la société d'expédition.

ATTENTION

- Risque de blessures suite à une mauvaise manipulation de l'appareil!
- Respecter toujours les instructions du manuel lors du déplacement et du positionnement de l'onduleur.
- Des lésions, des blessures graves ou des ecchymoses peuvent se produire si l'appareil est mal manipulé.

Pendant l'Installation Mécanique

DANGER

S'assurer que l'onduleur n'est pas connecté électriquement avant son installation.

ATTENTION

Perte de performance du système due à une mauvaise ventilation!

Une bonne ventilation doit être maintenue pendant le fonctionnement de l'appareil. L'entrée et la sortie d'air du ventilateur ne doivent pas être couvertes pour s'assurer que l'intérieur de l'appareil peut être suffisamment refroidi.

Pendant la Connexion Électrique

NOTICE

Toutes les connexions électriques doivent être conformes aux normes nationales et locales.

La connexion au réseau ne peut être effectuée qu'après avoir reçu

l'approbation de la société de réseau local.

 DANGER

Une tension létale existe!

Les groupes photovoltaïques produiront de l'énergie électrique lorsqu'ils sont exposés à la lumière du soleil et créeront ainsi des risques potentiels de choc électrique.

AVERTISSEMENT

Tous les câbles doivent être solidement fixés, intacts, correctement isolés et dimensionnés de manière adéquate.

Pendant l'Opération de l'Onduleur

AVERTISSEMENT

Ne pas ouvrir l'enceinte de l'onduleur lorsqu'il est en charge ou fonctionne.

Seul un onduleur intact et verrouillé peut assurer la sécurité de personnel et de propriété.

ATTENTION

Il y a un risque de brûlure!

Ne pas toucher les composants chauds de l'onduleur (par exemple, le radiateur) pendant le fonctionnement. Seul le commutateur DC / AC peut être touché pendant le fonctionnement.

Utiliser l'onduleur en suivant strictement les descriptions de ce manuel afin d'éviter des blessures évitables aux personnes et des dommages à l'appareil. Un arc électrique, un incendie ou une explosion peuvent se produire si cela s'effectue autrement et Sungrow ne sera responsable des dommages.

AVERTISSEMENT

Les opérations incorrectes suivantes peuvent provoquer un arc électrique, un incendie et une explosion à l'intérieur de l'appareil. Garder à l'esprit que ces accidents ne peuvent être traités que par du

personnel qualifié. Une mauvaise manipulation de ces accidents peut entraîner une faute ou un accident plus grave.

- **Brancher et débrancher le fusible HT côté DC lorsqu'il est sous tension;**
- **Toucher la fin des câbles qui n'ont pas d'isolation et qui peuvent encore être sous tension;**
- **Toucher la barre de bus de raccordement en cuivre, la borne ou d'autres pièces de rechange à l'intérieur du dispositif qui peuvent être sous tension;**
- **La connexion du câble d'alimentation est lâche;**
- **Les pièces de rechange, telles que les boulons, tombent dans l'onduleur;**
- **Fonctionnement incorrect par des personnes non qualifiées qui n'ont pas reçu de formation;**

AVERTISSEMENT

Avant toute opération de l'appareil, une évaluation préliminaire de l'arc électrique dans la zone d'opération est nécessaire. S'il y a une possibilité d'un arc électrique,

- **Les opérateurs doivent recevoir une formation de sécurité;**
- **Utiliser les meilleures pratiques pour évaluer les zones susceptibles d'être affectées par un arc électrique;**
- **Avant toute opération dans la zone qui pourrait être affectée par un arc électrique, il faut porter un équipement de protection individuelle (EPI) conforme à l'exigence. Une catégorie de PPE 2 est recommandée.**

Maintenance et Service

DANGER

Il y a un risque de dommages causés par l'onduleur ou de blessures corporelles en raison d'un mauvais fonctionnement du service!

- **Avant toute opération, exécuter les étapes suivantes:**
- **Débrancher d'abord le commutateur côté réseau, puis débrancher le commutateur CC;**

- **Attendre au moins 10 minutes jusqu'à ce que les condensateurs internes soient complètement déchargés;**
- **Vérifier, en utilisant un appareil de test approprié pour s'assurer qu'il n'y a pas de tension ou de courant.**

ATTENTION

Garder les personnes non qualifiées loin de l'appareil!

Un panneau d'avertissement temporaire et une barrière doivent être affichés pour garder les personnes non qualifiées loin de l'appareil en cours de connexion et de maintenance.

NOTICE

- **Redémarrer l'onduleur uniquement lorsque le défaut qui peut altérer les fonctions de sécurité de l'onduleur est supprimé.**
- **L'onduleur ne contient pas des pièces réparables par le propriétaire. Contacter le personnel autorisé local si un travail de service est requis.**

NOTICE

Ne pas remplacer les composants internes de l'onduleur sans autorisation. Des dommages à l'onduleur peuvent se produire et il peut annuler tout ou partie des droits de garantie de Sungrow.

NOTICE

Il y a un risque de dommages causés par l'onduleur en raison de décharges électrostatiques!

Les circuits imprimés contiennent des composants sensibles aux décharges électrostatiques.

- **Porter une bande de poignet mise à la terre lors de la manipulation des panneaux.**
- **Éviter le contact inutile aux panneaux.**

WARNING:**ELECTRIC****SHOCK****AVERTISSEMENT: RISQUE DE CHOC**

HAZARD. THE DC CONDUCTORS OF THIS PHOTOVOLTAIC SYSTEM ARE UNGROUNDED AND MAY BE ENERGIZED.	ÉLECTRIQUE. LES CONDUCTEURS DC DE CE SYSTÈME PHOTOVOLTAÏQUE NE SONT PAS MIS À LA TERRE ET PEUVENT ÊTRE MIS SOUS TENSION.
WARNING: Electric Shock Hazard. The DC conductors of this photovoltaic system are normally ungrounded but will become intermittently grounded without indication when the inverter measures the PV array isolation.	AVERTISSEMENT: Risque de choc électrique. Normalement, les conducteurs CC de ce système photovoltaïque ne sont pas mis à la terre, mais seront mis à la terre sans indication lorsque l'onduleur mesure l'isolation du réseau photovoltaïque.
CAUTION: Risk of Electric Shock, Do Not Remove Cover. No User Serviceable Parts Inside. Refer Servicing To Qualified Service Personnel.	ATTENTION: risque de choc électrique, ne pas retirer la couverture. Pas de pièces pouvant être réparées par l'utilisateur à l'intérieur. Consulter le personnel qualifié de service.
CAUTION: Risk Of Electric Shock a) Both AC and DC voltage sources are terminated inside this equipment. Each circuit must be individually disconnected before servicing, and b) When the photovoltaic array is exposed to light, it supplies a DC voltage to this equipment.	ATTENTION: Risque de choc électrique A) Les sources de tension AC et DC sont terminées à l'intérieur de cet équipement. Chaque circuit doit être déconnecté individuellement avant l'entretien, et B) Lorsque le réseau photovoltaïque est exposé à la lumière, il fournit une tension DC à cet équipement.
CAUTION: Risk of electric shock from energy stored in the capacitor. Do not remove cover until 5 minutes after disconnecting all sources of supply.	ATTENTION: risque de choc électrique par l'énergie stockée dans le condensateur. Ne pas retirer le couvercle jusqu'à 5 minutes après avoir débranché toutes les sources d'alimentation.
CAUTION: Hot surfaces – To reduce the risk of burns. Do not touch.	ATTENTION: surface chaude - Pour réduire le risque de brûlure. Ne pas le toucher.
CAUTION: Check user manual before	ATTENTION: Vérifier le manuel

service.	d'utilisateur avant l'utilisation.
----------	------------------------------------

2 Product Description

2.1 Intended Usage

SG125HV/SG125HV-20; a transformerless three-phase PV grid-connected inverter, is an integral component in the PV power system.

The inverter is designed to convert the direct current power generated from the PV modules into grid-compatible AC current and feeds the AC current to the utility grid. The intended usage of the inverter is illustrated in Fig. 2-1.

WARNING

Inverter cannot connect the PV strings whose positive and negative terminals need to be grounded.

Do not connect any local load between the inverter and the AC circuit breaker.

Inverter is applicable only to the grid-connected PV system. Any other usage is strictly forbidden.

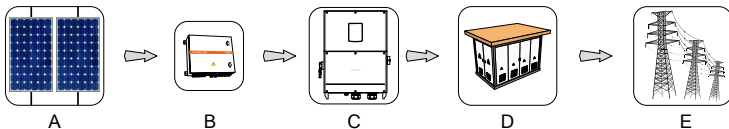
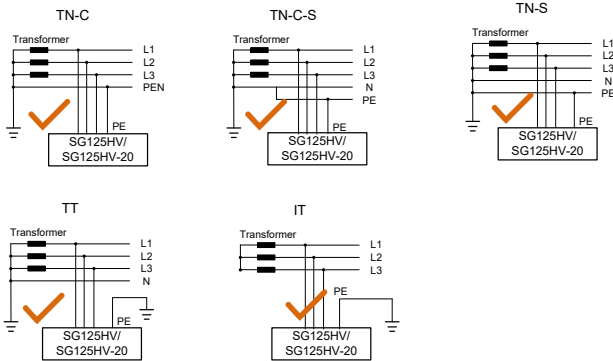

Fig. 2-1 Inverter application in PV power system

Item	Description	Note
A	PV strings	Monocrystalline silicon, polycrystalline silicon, and thin-film without grounding
B	Combiner Box	Combine the DC current of several PV string inputs
C	Inverter	SG125HV/SG125HV-20
D	Transformer	Convert the inverter output low-voltage AC voltage into the grid-compatible medium-voltage level.
E	Utility grid	TN-C, TN-S, TN-C-S, TT, IT

The following figure shows the common grid configurations.



If the Anti-PID function is to be enabled, ensure that:



- The inverter is applied in the IT system.
- The downstream transformer meets the requirements described in 6.2.1 Medium-voltage Transformers.
- The AC cables meet the requirements described in 6.2.2 AC Cable Requirements.

2.2 Product Introduction

2.2.1 Model Description

The model description is as follows:

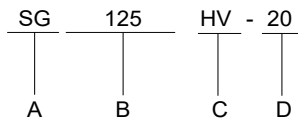

- A: Code of PV grid-connected inverter
- B: Code of power level
- C: High voltage input (1500Vdc)
- D: Code of product version

Tab. 2-1 Version difference

Model	PID function	Night SVG function
SG125HV	Optional	No
SG125HV-20	Yes	Yes

2.2.2 Appearance

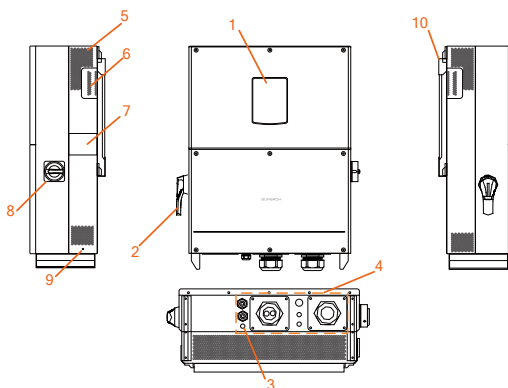

Fig. 2-2 Appearance

* Pictures are indicative only. Product in kind prevail.

No.	Name	Description
1	LED indicator panel	HMI interface to indicate the present working state of the inverter.
2	DC switch	Protective components to safely disconnect DC side current.
3	Waterproof air valve	-
4	Electrical connection area	Includes DC terminal, AC terminal and RS485 communication terminal.
5	Air outlet	Controlled forced-air cooling method. Ensures proper ventilation.
6	Handles	Handles are designed for transporting, installing and disassembling the inverter
7	Cover plate of the fan	The fan is located on the back of the cover plate and used for the forced cooling of the inverter
8	AC switch	Serviced as an automatic overcurrent device
9	PE second terminal	User can connect this terminal as per requirements.
10	Hanger	Hang the inverter on the bracket.

2.2.3 Dimensions

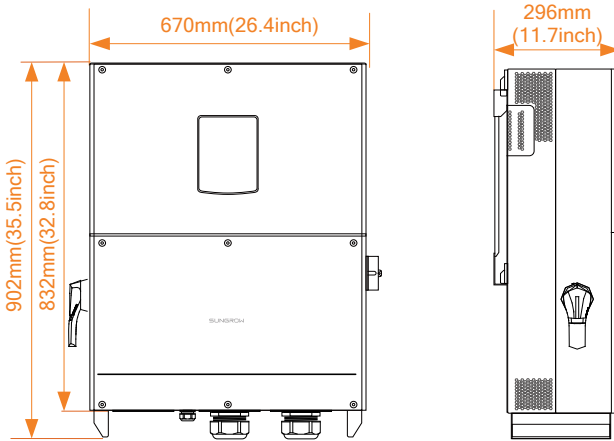

Fig. 2-3 Dimensions of the inverter

2.2.4 LED Indicator Panel

As an HMI, the LED indicator panel on the inverter front panel indicates the present working state of the inverter.

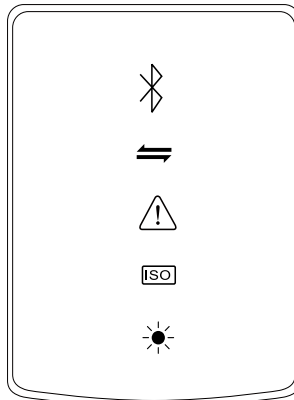







Fig. 2-4 LED indicator panel

Tab. 2-2 LED indicator description

LED indicator	LED color	LED state	Definition
Bluetooth 	Blue	ON	The Bluetooth communication is connected, the communication channel has no data interaction
		OFF	No device connected to the inverter through the Bluetooth.
		Periodical flash	The Bluetooth communication is connected and there is data communication
Communication 	Blue	OFF	The RS485 communication cable is not connected or the communication channel has no data interaction
		Periodical flash	The RS485 communication cable is connected and the communication channel has data interaction
Fault/PID 	-	OFF	No alarm or fault has occurred and PID function is not enabled
	Red	ON	A fault occurred and the device cannot connect to the grid
		Periodical flash	Fault recovery
	Green	ON	PID function is running
Periodical flash		PID function exception	
Earth impedance abnormal 	Red	OFF	No fault occurred
		ON	An earth impedance short-circuit fault occurred (the device cannot connect to the grid)
Normal operation 	Green	OFF	Both the AC and DC is powered down, or a fault occurs
		Periodical flash	The DC or AC is powered on and the device is in standby or startup state (not feeding power to the grid)
		ON	The device is connected to the

LED indicator	LED color	LED state	Definition
			grid and operating normally

2.2.5 DC Switch

The DC switch is used to disconnect the DC current safely whenever necessary.

The inverter operates automatically when input and output requirements are met. Turn the DC switch to the "OFF" position to stop the inverter when a fault occurs or when you need to stop the inverter.



Turn the DC switch to the "ON" position before restarting the inverter.

2.2.6 AC Switch

The AC switch is used to disconnect the inverter from the AC grid. Turn the switch to the OFF position and the inverter disconnects from the AC grid.



Turn the AC switch to the ON position before restarting the inverter.

2.3 Technical Description

2.3.1 Circuit Diagram

Fig. 2-5 shows the main circuit of the inverter.

The MPPT is utilized for DC input to ensure the maximum power from the PV array at different PV input conditions.

The inversion circuit converts the DC power into AC power and feeds the AC power to the utility grid through the AC terminal. The protection circuit is equipped to ensure the safe operation of the device and personal safety.

The DC switch is used to disconnect the DC current safely. The inverter provides standard RS485 ports for communication. Users can also check running data and set related parameters via the SunAccess APP.

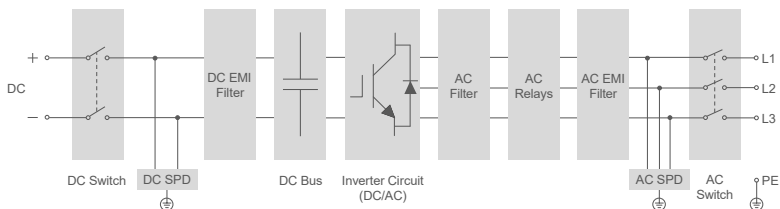

Fig. 2-5 Circuit diagram of SG125HV/SG125HV-20

2.3.2 Function Description

- Inversion function

The inverter converts the DC current into grid-compatible AC current and feeds the AC current into the grid.

- Data storage

The inverter achieves the running information, fault records and etc.

- Parameter Configuration

The inverter provides various parameter settings. You can set the parameters via the phone's APP to change the requirements of the device or optimize the performance of the device.

- Communication Interface

Standard RS485 port can be connected to monitoring a device and PV system.

- Protection Function

- AC short circuit protection
- Ground insulation resistance monitoring
- Grid voltage monitoring
- Grid frequency monitoring
- Residual current protection
- DC injection of AC output current monitoring
- Internal temperature monitoring
- Anti-islanding protection
- DC over-voltage protection
- Over-current protection
- Power module over-temperature protection

- Anti-PID function (Optional)
- PID recovery function (Optional)
- Night SVG function (Optional)

2.3.3 Derating

Output derating is a way to protect the inverter from overload or potential faults. Situations requiring inverter power derating are:

- Ambient temperature is too high
- Grid voltage is too low
- Fluctuations of external power level
- Input voltage is too high
- Grid frequency* is too high

Note: *The over-frequency curve may vary with the country setting.

Power Limit Setting

Inverter output power can be adjusted via the APP interface or remote grid dispatch from the grid company.

Over-temperature Derating

High ambient temperature, a broken fan or poor ventilation will lead to inverter power derating.

- When the IGBT module temperature exceeds the upper limit, the inverter will derate power output until the temperature drops within the permissible range.
- When the inverter internal temperature exceeds the upper limit, the inverter will derate power output until the temperature drops within the permissible range.

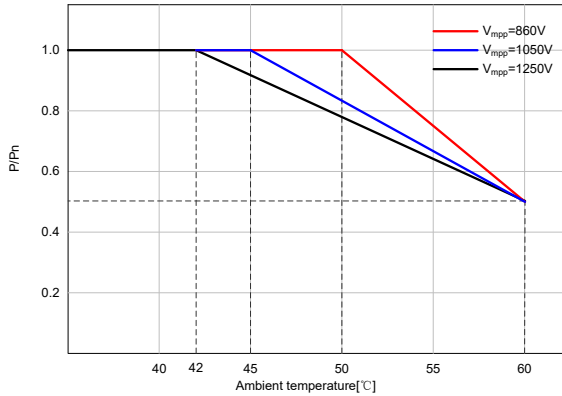

Fig. 2-6 Over-temperature Derating(Pf=1)



Lower limit of the over-temperature derating: about 50% of the nominal power.

When both the module temperature and the internal temperature meet the derating condition, inverter limits its power according to the lower power limit value of the two.

Grid Under-voltage Derating

When the grid voltage is low, the inverter will derate the output power to make sure the output current is within the permissible range. Once the grid voltage is within Vmin...600V, the inverter will derate the output power.

$$\begin{cases} P_o = \frac{V_{grid}^2}{600^2} \times 125kVA & V_{min} \leq V_{grid} < 570V \\ P_o = \frac{V_{grid}}{600} \times 125kVA & 570V \leq V_{grid} \leq 600V \\ P_o = 125kVA & 600V \leq V_{grid} \leq V_{max} \end{cases}$$

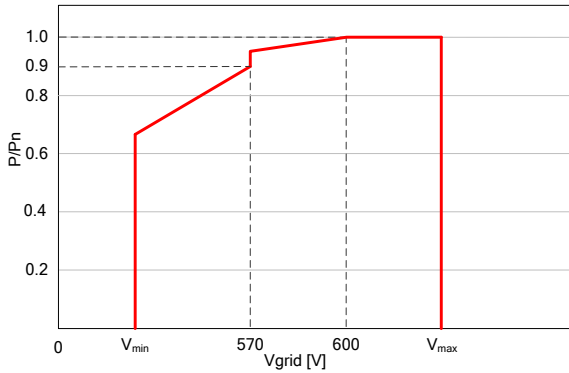

Fig. 2-7 Grid under-voltage derating(Pf=1)

High input voltage derating

If the input voltage is too high, the inverter may derate the power output. The relationship between the input voltage and the power derating is shown in the figure below.

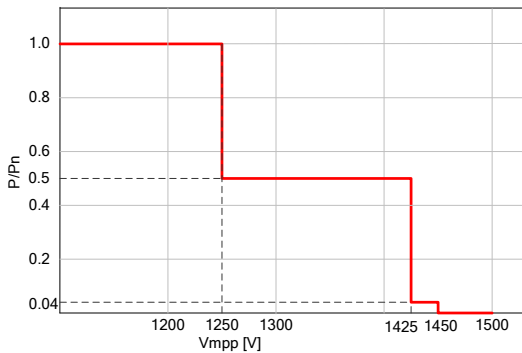
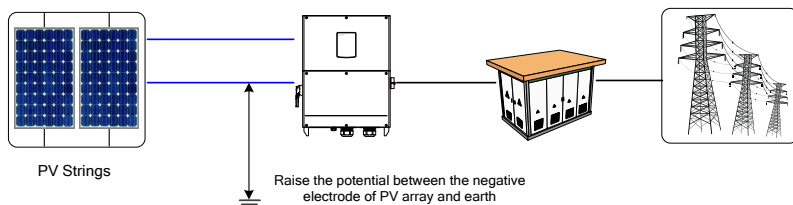

Fig. 2-8 Input voltage and the power derating(Pf=1)

2.3.4 PID Function

SG125HV/SG125HV-20 provides Anti-PID function and PID Recovery function, and achieves raising the potential between the negative electrode of PV array and earth by using internal PID function module.



Anti-PID Function

When the inverter is running, the PID function module suppresses the PID effect by raising the potential between the negative electrode of PV array and earth to a positive value.

PID Recovery Function

When the inverter is not running, the PID function module imposes a reverse potential to the PV modules so as to recover the PV modules in which PID effect has occurred.



If the PID function is to be enabled, ensure that all PV modules in the array of power station to which SG125HV/SG125HV-20 belongs must be P-type. Otherwise, the PID function will be abnormal. If other types of PV modules need to be selected, please contact SUNGROW.

3 Installation Flow

Fig. 3-1 shows the installation flow of the inverter and Tab. 3-1 gives a detailed explanation.

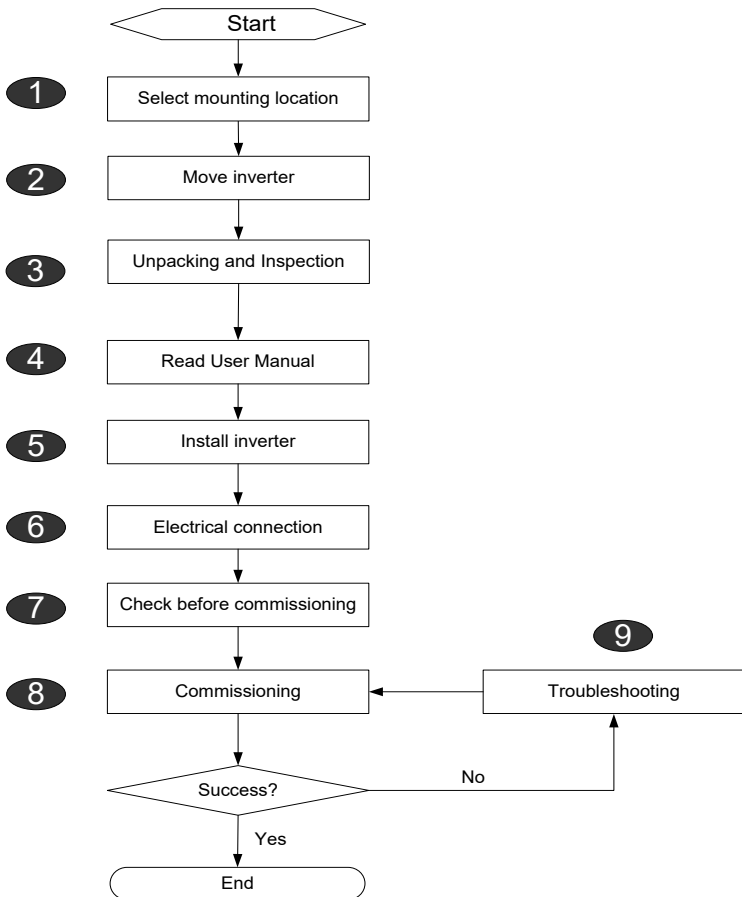

Fig. 3-1 Installation flowchart

Tab. 3-1 Description of installation flow

Procedure	Description	Reference
1	Select optimal installation site	5.1
2	Move the inverter to the installation site	5.2
3	Unpacking and inspection	4.1
4	Read the User Manual, especially the section on "Safety Instruction"	1
5	Install the inverter to the selected installation site	5.3
6	Electrical connection; DC side connection; AC side connection; Ground connection; Communication connection.	6.3~6.7
7	Inspection before commissioning	7.1
8	Start up the inverter and configure corresponding parameters.	7.2
9	Troubleshooting	9.1

4 Unpacking and Storage

4.1 Unpacking and Inspection

Despite being strictly tested and checked, damage may still occur to the inverter during shipping. Therefore, the first thing you should do after receiving the device is to conduct a thorough inspection.

- Check the packing for any visible damage upon receiving.
- Check the completeness of delivery contents according to the packing list.
- Check the inner contents for damage after unpacking.

In case any damage is found, please contact Sungrow or the forwarding company.

Do not dispose of the original packaging. It is best to store the inverter in its original packaging.

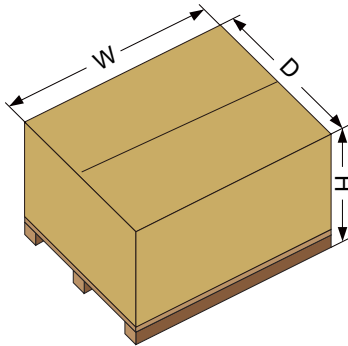

Fig. 4-1 Inverter paper packaging

Dimensions	W	H	D
In mm	1098	608	848
in inch	43.2	23.9	33.4

4.2 Identifying Inverter

The nameplate is attached to one side of the inverter and the packaging carton separately. It provides information on type of inverter, important specifications, marks of certification institutions, and serial number which are available and identified by Sungrow. Take SG125HV as an example:

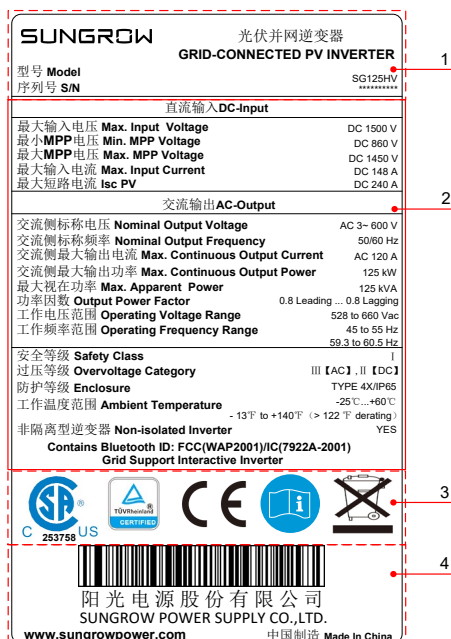

Fig. 4-2 Inverter nameplate

*Image shown here is indicative only. Product in kind prevail.

Item	Description
1	SUNGROW logo and product type
2	Technical data of inverter
3	Marks of certification institutions of inverter
4	Company name, website and origin

Tab. 4-1 Description of Icons on the Nameplate

Icon	Description
	CSA mark of conformity. The inverter is in compliance with directives of US and CAN.
	TUV mark of conformity. The inverter is in compliance with directives of TUV.
	CE mark of conformity. The inverter is in compliance with directives of CE.
	Refer to the corresponding instructions.
	Don't dispose of the inverter with the household waste.

4.3 Scope of Delivery

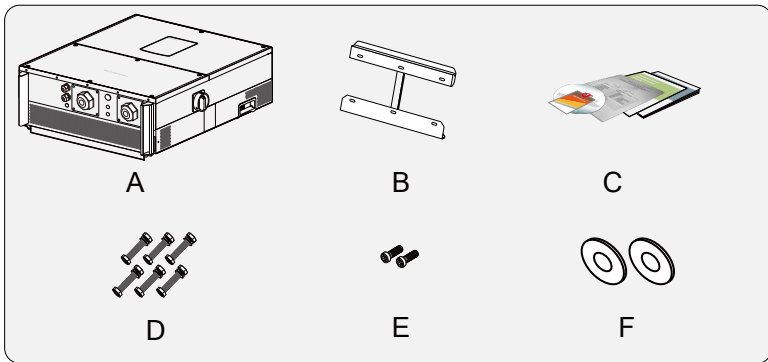

Fig. 4-3 Scope of delivery

Item	Name	Description
A	Inverter	---
B	Bracket	Used to connect the inverter to the installation site.
C	Documents	Quality certificate, packing list, Test Report, CD and quick user manual
D	Fasten set	Six units to fasten bracket to metal frame.
E	Fix screw	Two M4×16 screws to connect the inverter to the bracket.

F	Big flat washer	Two additional big flat washers are within the scope of the delivery for future use if needed.
---	-----------------	--

4.4 Inverter Storage

Proper storage is required if the inverter is not installed immediately. Sungrow shall hold no liability for the damage of the device, in appearance or the failure of internal components, caused by improper storage of the device as specified in this manual. The inverter must be packed into its original carton with the desiccant bags inside.

- The inverter must be packed into its original carton with the desiccant bags inside.
- Seal the packing carton with adhesive tape.
- Store the inverter in a dry and clean place to protect it against dust and moisture.
- Relative storage temperature: $-40^{\circ}\text{C} \sim 70^{\circ}\text{C}$ ($-40^{\circ}\text{F} \sim 158^{\circ}\text{F}$); Relative humidity: 0-95%.
- Stack the inverters in at most three layers. Do not store the inverters in stack for more than half a year if the stack layer is more than three.

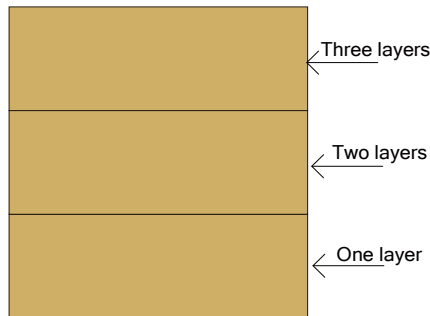

- Keep the inverter away from the chemical corrosive materials to avoid possible corrosion.
- Periodically (recommended: six months) check for any visible damages during the storage period. Replace the packing material during the storage period as necessary.
- The packing should be upright.

- If the inverter has been stored more than half a year, the qualified persons should thoroughly check and test it before using.

5 Mechanical Installation

5.1 Installation Site Selection

Select an optimal installation site for safe operation, long service life and outstanding performance.

- Take the load capacity of the wall into account. The wall (concrete wall or metal frame) should be strong enough for the weight of the inverter over a long period.
- Install the inverter in a convenient location for electrical connection, operation and maintenance.
- Do not install the inverter on the wall made up of flammable materials.

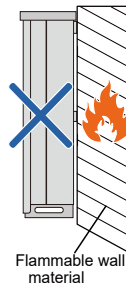

- Do not install the inverter near flammable materials or gas.

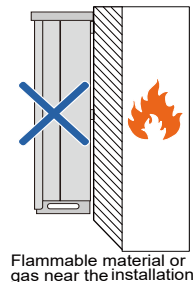

- Place the inverter at eye level for easy viewing and operation.

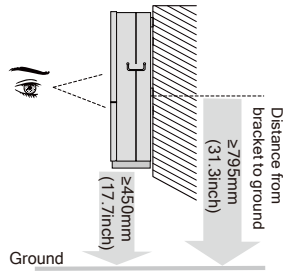

- Install the inverter vertically or at a maximum back tilt of 75 degrees. Do not install the inverter leaning forward or upside down.

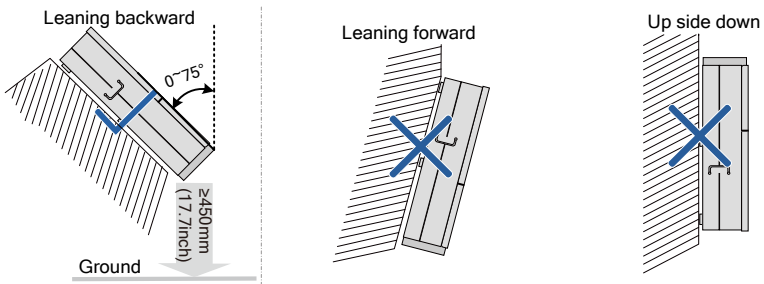

- If the included angle between the installation site and the plumb line is greater than 75°, install the inverter on the frame to meet the requirement for installation angle. The frame and the inverter are installed as shown in the following figure.

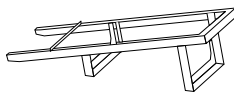

Frame

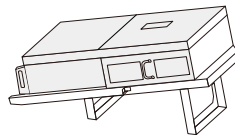

Installation complete

- For detailed frame installation solution, contact Sungrow.

- With an IP65/NEMA 4X protection rating, the inverter can be installed both outdoors and indoors.
- To achieve better running effect. The ambient temperature should be within $-25^{\circ}\text{C} \dots 60^{\circ}\text{C}$ (-13°F to 140°F). The inverter will operate with power derating if the temperature is too high.
- The relative humidity range of the installation site is 0-100%.
- Ensure there is enough space for convection (The fans are maintained on the left side of the inverter, and a larger clearance is required.)



Max. ambient temperature: 60°C ($+140^{\circ}\text{F}$)



Min. ambient temperature: -25°C (-13°F)



Relative humidity: **0-100%**

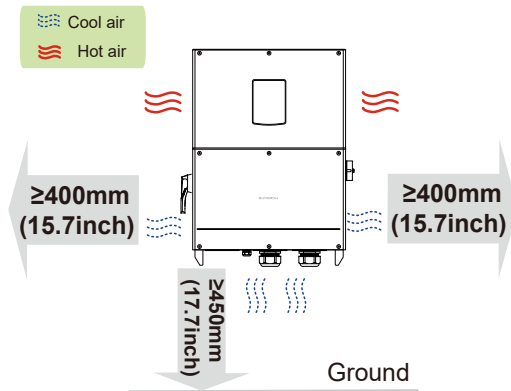

- When installing multiple inverters, it is recommended to install multiple devices side by side.

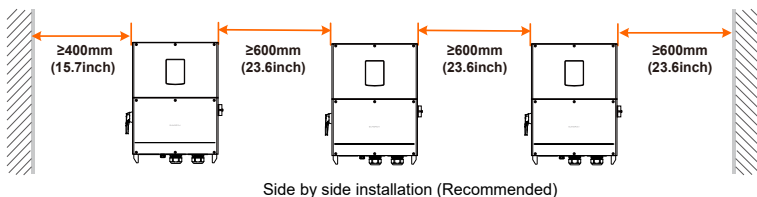

- 在环境温度为 $-25^{\circ}\text{C} \sim 45^{\circ}\text{C}$ 时，可以采用上下叠加和交错安装的方式。

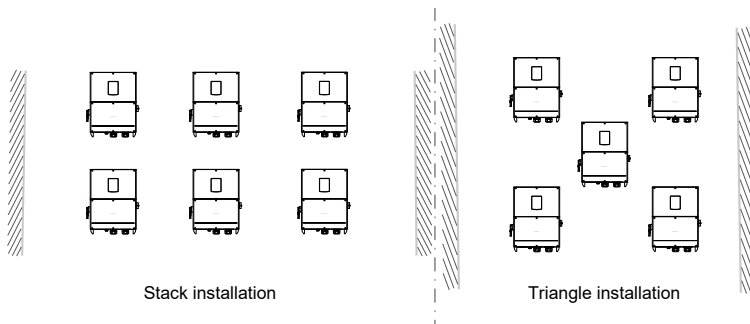

- When the devices are installed back to back, make sure the clearance in between is greater than or equal to 100mm (3.9inch).

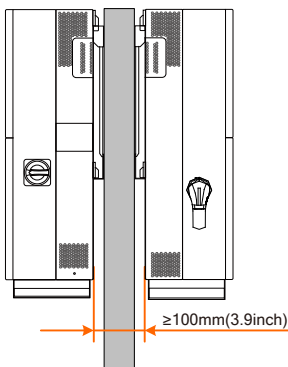

- Do not install the inverter in a confined space. The inverter will not work normally if otherwise.
- Install the inverter where children cannot reach.
- Do not install the inverter near residential areas. Noise can be produced during inverter operation which may affect the daily life.

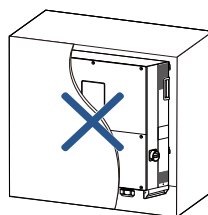

5.2 Moving Inverter to Installation Site

To install the inverter, remove the inverter from the packaging and move it to

the installation site. Follow the instructions below as you move the inverter:

- Always be aware of the weight of the inverter.
- Lift the inverter by grasping the handles on both sides of the inverter.
- A minimum of two people or proper moving devices should be used to move the inverter.
- Do not release the equipment unless it has been secured firmly.

5.3 Installation Tools

Gather the following tools before installation:

- Torque wrench
- Screwdriver
- Wire stripper
- Terminal crimping device
- Alcohol blast burner (or hot air blower)
- Allen wrench
- Meg-ohmmeter or multimeter
- Other auxiliary tools or spare parts

5.4 Installing the Inverter

Inverter is installed to the wall by the bracket enclosed in the packing. If you do not use the supplied bracket, you can drill holes as per specifications below:

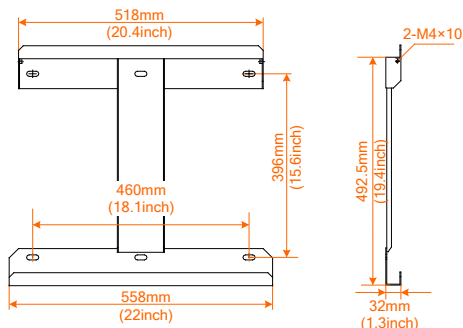

Fig. 5-1 Dimensions of the bracket (figures in inch)

The stainless fasteners are supplied for attaching the bracket to metal frame.

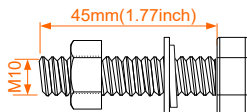

Fig. 5-2 Dimensions of fastener for metal frame (figures in mm)



To install the inverter to concrete walls, the user needs to purchase expansion bolts with proper size (recommended: M10*65) to attach the bracket to concrete walls.

5.4.1 Installing to Metal Frame

- Step 1** Remove the bracket and fasteners from the packaging.
- Step 2** Place the bracket to the chosen metal frame and adjust it to proper position and height.
- Step 3** Mark the position for holes, drilling according to the hole positions of the bracket.
- Step 4** Drill holes according to the marks made before. If the shape of the metal frame does not match the bracket, re-drill holes on the bracket according to the metal frame.

Mark positions

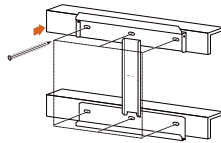

Drill holes

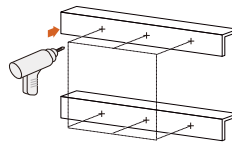

Step 5 Secure the bracket to the metal frame firmly with the supplied fastener. The torque of the fasten nut is 35 N·m.

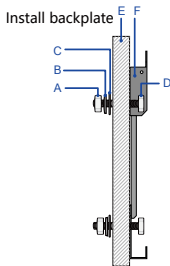

No.	Name	Description
A	Hexagon nut	M10
B	Spring washer	-
C	Flat washer	-
D	Screw bolt	M10*45
E	Metal frame	-
F	Bracket	-

Step 6 Lift the inverter above the bracket and then slide down to make sure they match perfectly.

Step 7 After putting the inverter on the bracket, secure the inverter to the bracket with two M4×16 screws (tighten the screw with its own nut).

Mount the inverter

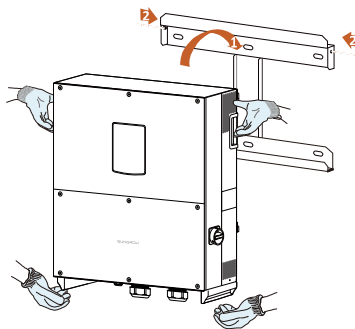

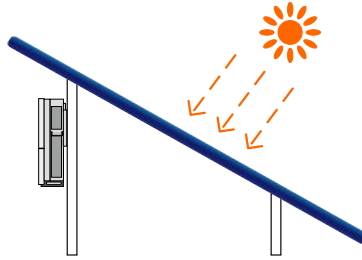

5.4.2 Installing to Concrete Wall

Step 1 Remove the bracket and corresponding fasteners from the packaging.

Step 2 Place the bracket on the chosen concrete wall and adjust it to proper position and height.

Step 3 Mark the position for holes, drilling according to the hole positions of the bracket.

Step 4 Drill holes according to the marks made before.

⚠ DANGER

Check to ensure that there is no other electronic or plumbing installed inside the wall before drilling holes.

Mark positions

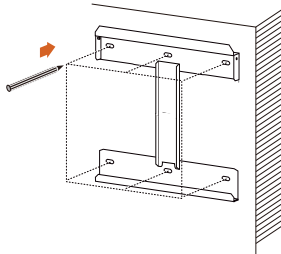

Drill holes

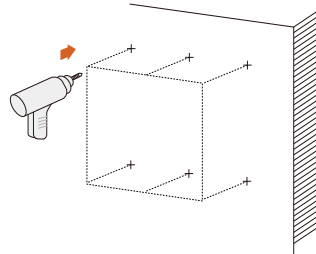

Step 5 Secure the bracket to the wall firmly by the supplied expansion bolt sets. Torque of the fasten nut is 35 N·m.

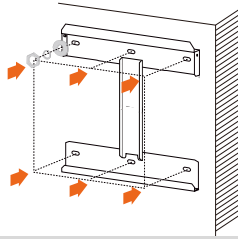

- If the installation location is lower, the inverter can be directly linked to the bracket, please follow step 6 and then jump to Step 10.
- If the installation location is higher, the inverter can not be directly linked to the bracket, please perform steps 7 to 10.

Step 6 Lift up inverter above the bracket and then slide down to make sure that the recesses on the back of the inverter fit perfectly together with the bracket.

Step 7 Screw two M12-screwed, lifting rings to the screw holes on top of the inverter.

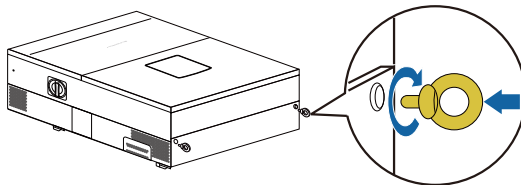

M12-screwed lifting ring is a standard component. It is not within the scope of delivery. Please purchase from the market if needed.

Step 8 Thread a rope (with sufficient load-carrying capacity) prepared beforehand through the two lifting rings to lift the inverter and lift the inverter to the level of the attached bracket or adjacent location.

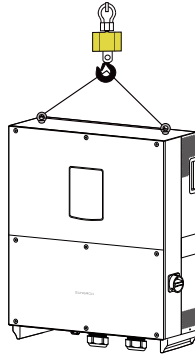
**NOTICE**

Please keep the inverter balanced during the whole process of inverter lifting. Inverter may hit the wall or other obstacles if you're not careful.

Step 9 Fit the inverter to the bracket, refer to step 6.

Step 10 After you fit the inverter to the bracket, fasten the inverter to the bracket with two M4×16 screws.

Mount the inverter

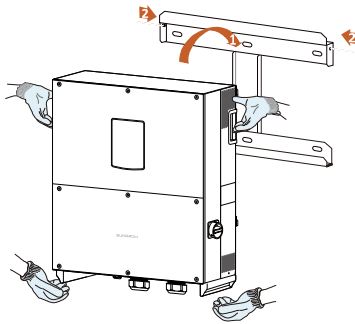

6 Electrical Connection

Once the inverter is secured to the installation site, it can be connected to the PV system.

All electrical connections must comply with local regulations and related electrical rules.

WARNING

Improper cable connection may lead to a fatal injury or permanent damage to the device.

Cable connections should only be done by qualified professional personnel.

Always keep in mind that the inverter is AC and DC redundancy power supplied. Electrical operators must wear proper personal protective equipment: helmet, insulated footwear and glove, etc.

6.1 Terminal Description

6.1.1 Appearance

Inverter electrical connection terminals and cable entries are all at the inverter junction box as shown in Fig. 6-1.

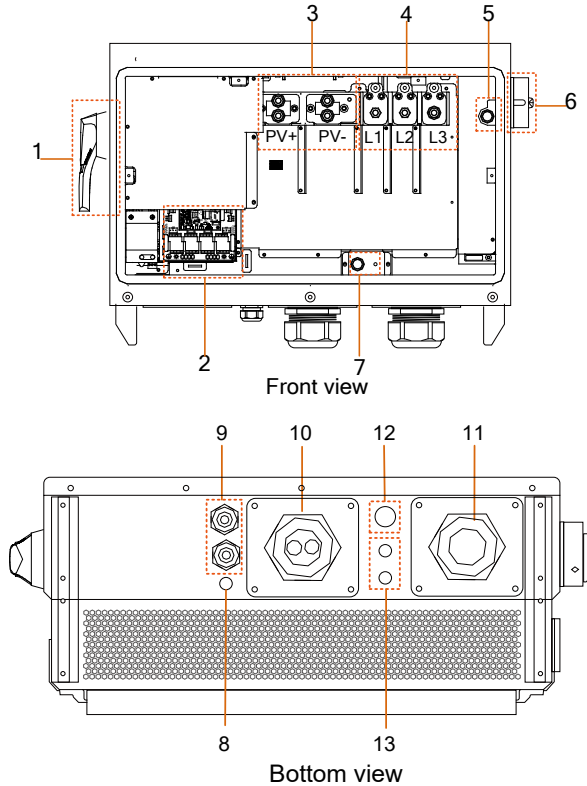

Fig. 6-1 Cable connection area

*Pictures are indicative only. Please in kind prevail.

No.	Name	Description
1	DC switch	Protective components to safely disconnect DC side current.
2	Configuration circuit board	Communication cable connection and configuration
3	DC crimping terminal	DC input cable access
4	AC crimping terminal	AC output cable access
5	AC PE terminal	AC PE cable access, M10X30 fastening screws
6	AC switch	Serviced as an automatic overcurrent device

No.	Name	Description
7	DC PE terminal	DC PE cable access, M6 × 16 (right) or M10X30 (left) fastening screws
8	Waterproof air valve	-
9	Communication cable gland	For Communication cable connection Knockout diameter for communication cable is 28.5mm.
10*	DC cable gland	For DC cable connection Knockout diameter for DC cable is 75.8mm. (The proper range of DC cable external diameter is 20~26mm)
11*	AC cable gland	For AC cable connection Knockout diameter for AC cable is 75.8mm. (The proper range of AC cable external diameter is 38~56mm)
12	AC cable gland for connecting Tracker control cabinet	Reserved
13	DC input plug-in terminal for connecting Tracker control cabinet	Reserved

NOTICE

Connect the cable through the corresponding interfaces on the bottom of the inverter during power cable and communication cable connection;

Tie the communication cables (e.g. RS485 and the dry contact) to prevent interference with the power cables.

*在现场可选择使用导线管代替格兰头，操作步骤如下。（以交流侧为例，直流侧同理）

Step 1 拆卸可移动封板（M6 内六角梅花螺丝刀）

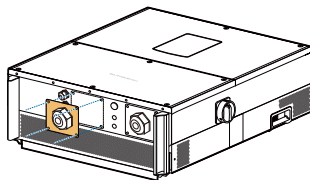

Step 2 拧掉格兰头 (扳手*2, 开口 86mm)

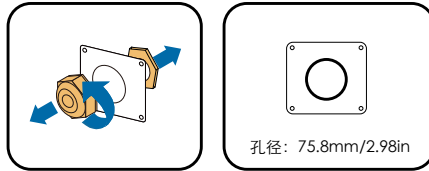

6.1.2 Dimensions of Terminal

Before selecting the cable side terminals, please notice the dimensions of the AC & DC terminals specified in the figure to make sure the selected terminals are proper.

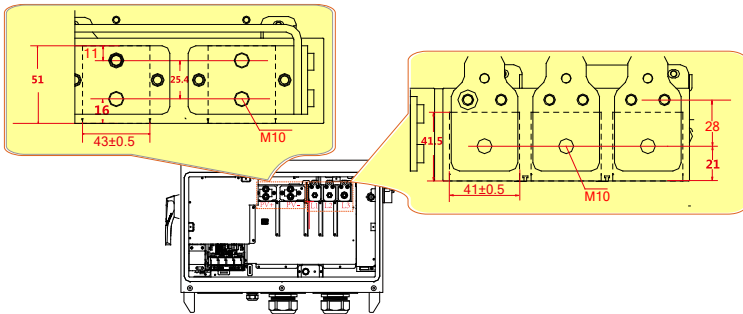



We provide the socket head cap screw whose matching flat washer can enhance the fastening function of the nuts.

The maximum permitted temperature for the DC and AC crimping terminal is 90°C(+194°F).

6.2 AC Side Cable Connection

6.2.1 AC side requirements



Connection to the utility grid must be done only after receiving approval from the local utility company.

Before grid-connection, verify to make sure the grid voltage and frequency meet the requirements of the inverter. Contact the local utility grid company with any connectivity issues. For detailed parameters, please refer to 11.1 Technical Data.

AC Circuit Breaker

An independent circuit breaker is installed outside the output side of the inverter to ensure that the inverter can be disconnected safely.

Standard	Recommended rated voltage	Recommended rated current
UL	600V	150A
IEC	690V	160A



- The selection of AC circuit breaker should comply with local standards.
- The ultimate short-circuit breaking capacity of the AC circuit breaker is determined according to on-site transformer configuration and system solution. If there are any problems, please contact Sungrow to confirm the technical solution.

NOTICE

- **It is not allowed to install more than one inverter per fuse or circuit breaker.**

• **It is not allowed to connect loads between inverter and circuit breaker.**

Multiple Inverters in parallel Connection

If multiple inverters are connected to the LV side of the MV transformer in parallel, and the HV side is connected to the MV grid, please respect following requirement:

When more than 25 inverters are connected to a single winding of the transformer, please contact Sungrow to confirm the technical solution.

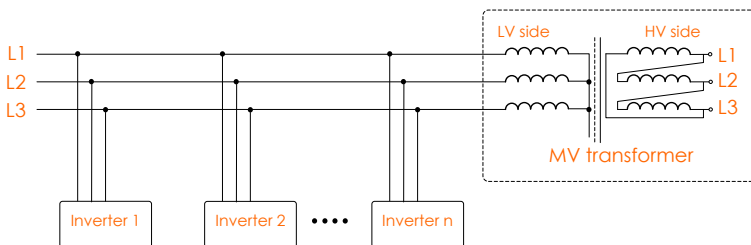
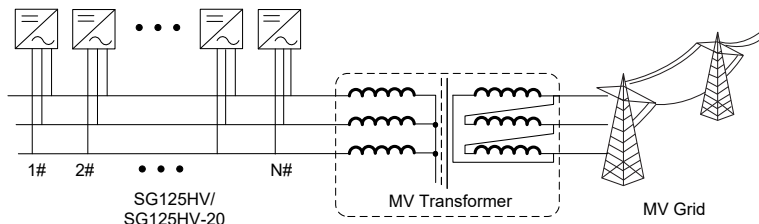

Fig. 6-2 Multiple Inverters in parallel Connection

Medium-voltage Transformers

SG125HV/SG125HV-20 Transformer Technical Requirements

- Nominal Frequency: 50Hz/60Hz
- Primary Voltage: According to the grid-connection point voltage
- Secondary Voltage: 600Vac (Line to Line, allowed range:480~690Vac)



Note: Additional phase monitoring devices may be required for grounded primary (utility side) transformers. Engineers should confirm the protection requirement prior to selecting the transformer.

- When the utility side phase monitoring devices are absent, and the system fully relies on inverter protection to shut down during the loss of phase fault at the utility side, Sungrow recommends a transformer with a DELTA connection on the utility side.
- The transformer must be suitable for operation with inverters which work with PWM modulation.
- Short Circuit Impedance $Z(\%)$ of the transformer should be 6%(the impedance allows 10% error margins.).
- The transformer should be capable of withstanding a certain level of harmonic current. The maximum total harmonic current is 3% of the fundamental current at nominal power output.
- The transformer should be capable of withstanding a certain level of DC current injection 0.5% of the fundamental current at nominal power.
- The transformer should be capable of withstanding a certain degree of phase imbalance 5% of the current at nominal power.
- The protection degree of the transformer should be taken into account to coordinate with the inverters.
- For thermal rating, the load curve of the transformer and the ambient conditions at the respective installation site should be taken into account.
- The applicable country-specific standards should be taken into account.
- The short-circuit apparent power of the transformer at grid-tied point should be no less than 10 times of its rated power
- If the Anti-PID function is to be enabled,
 - 1) Neutral line grounding is strictly prohibited at the LV side of transformer.
 - 2) The transformer's secondary windings shall be able to handle $V_{rms}=842V$ phase to ground voltage, which must also be considered when selecting the cables and devices connected with the LV side of the transformer, including the SPDs, any meters, etc.
 - 3) The maximum continuous working voltage and action voltage of the low-voltage side lightning protection device of the grid-connected transformer must meet the requirements. The "3+1" method is recommended as shown in Fig. 6-3, where the maximum continuous working voltage of M1-M3 are 500V, M4 is more than 750V.

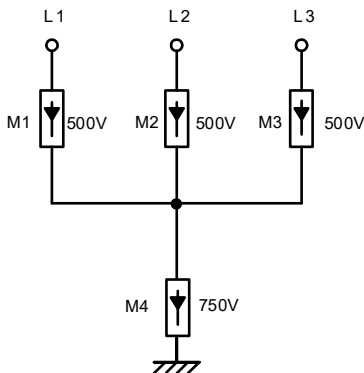

Fig. 6-3 The schematic diagram of AC SPD

6.2.2 Grid Connection

The AC terminal block is on the bottom of the inverter. AC connection is the three-phase-three-wire grid +PE connection (L1, L2, L3 and PE).

AC Cable Requirements

Select AC cables according to the following factors:

- Grid impedance complies with the specifications below to avoid accidental shortcircuit or output power derating.

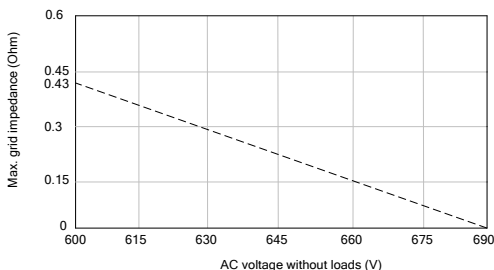

- Considering the voltage drop and other conditions, please enlarge the cable dimension. Power loss of the cable should be less than 1% of the nominal power.
- Withstand ambient temperature.
- Cable layout and installation conditions (inside wall, underground, free air, etc.)

- UV resistance and so on.
- The maximum operation temperature of the cable should no less than 90° C(+194°F).
- The current rating of the cable should be selected in accordance with the maximum AC output current of the inverter.
- The voltage rating of the cable should be no less than 600Vac.

(*If the Anti-PID function is to be enabled, the rating should be no less than 1000Vac)

- The Conductor type can be copper wire or aluminum wire.
- The AC cable must be designed in accordance with the local installation requirements.
- If the aluminum cable is selected, in order to ensure a reliable electrical connection, use the albronz filter or the copper and aluminum conversion terminal to avoid direct contact between the AC copper bar and the aluminum cable.

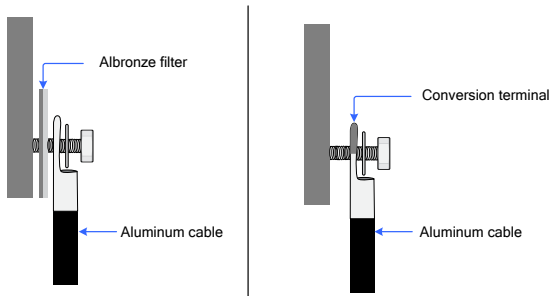

Beware the direction of the albronz filter, i.e. the copper side must be closely attached to the copper bar and the aluminum side must be closely attached to the aluminum connection terminal.

NOTICE

Directly connecting the aluminum cable to the copper bar will cause abnormal operation or even device damage.

Connecting the Inverter to Grid

⚠ DANGER

High voltage inside the inverter!

Ensure all cables are voltage-free before electrical connection.

Do not connect the AC circuit breaker until all inverter electrical connections are completed.

Step 1 Disconnect AC circuit breaker to prevent it from inadvertently reconnecting.

Step 2 Loosen the six screws (M6×16) on the lower connection cabinet.

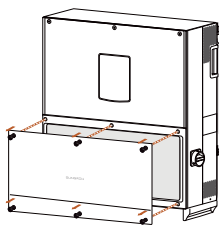

Step 3 拆下防护绝缘板。

Step 4 Strip off AC cables as shown below.



For flexible cables (stranded wires), use crimping lugs.

The cross-section of the AC cable conductor must be sized in order to prevent accidental disconnections of the inverter from the grid due to high impedance of the cable that connects the inverter to the power supply point.

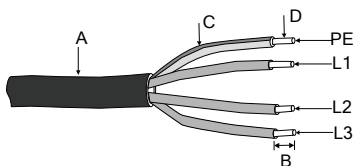

No.	Description	Remark
A*	Protective layer /Conduit	-
B	Length of insulation to be stripped off	Refer to Fig. 6-4Crimping the lugs
C	Insulation layer	-
D	Cross section of AC cables	Range: 70mm ² -185 mm ² (AWG2/0-350Kcmil)

Step 5 Insert the end of the AC cable into the crimping lug that matches with the M10 bolt and tighten it with proper tool.

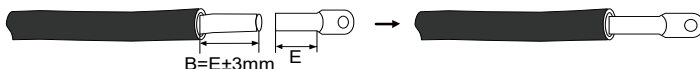
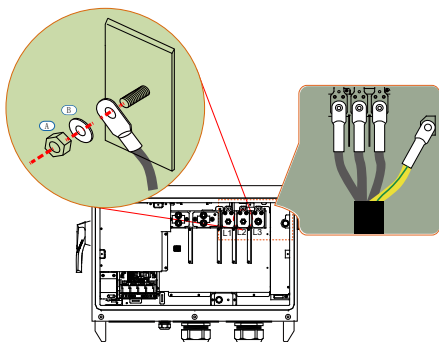

Fig. 6-4 Crimping the lugs

Step 6 Install the heat-shrinkable tubing.

Step 7 Connect the AC cable to the corresponding terminals.

* For torque specifications, refer to 11.2 Tightening Torques.



Item	Name
A	Nut
B	Disc spring

*Images shown here are for reference only! Actual product you receive may differ.

NOTICE

- It is unnecessary to distinguish between phases during AC cable connection for the inverter has self-adaptive capacity.
- Observe the pin assignment of AC terminal block. If a phase wire is connected to the “PE” terminal, it may permanently damage the inverter.
- Please avoid squeezing the cable insulation layer into the AC terminal. Improper connection may affect the normal operation of the inverter.
- During AC cable connection, the cables inside the lower part of the device should be bent to be surplus in length. In this way, cable dropping or loosening, which can cause arc or other problems impairing functionality of the device, due to self-weight of the cables

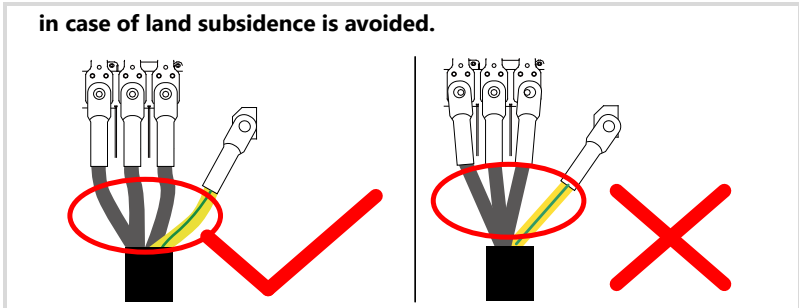

Step 8 Screw cap-nut tightly onto the cable.

Step 9 Seal the gaps between the AC cable and the gland inside the lower part of the cabinet with duct seal.

NOTICE

Seal the gap between the cable and the gland/conduit with duct seal or other suitable materials to prevent the entry of foreign bodies or moisture and ensure long-term and normal operation of the inverter.

6.3 Connecting Inverter to PV Arrays

DANGER

Lethal voltage exists!

PV arrays generate electrical energy when exposed to light and thus can create an electrical shock hazard.

WARNING

Make sure that the PV impedance to the ground is proper before connecting the PV array to the inverter.

6.3.1 PV Input Configuration

NOTICE

The following requirements must be adhered to. Failure to do so may void any or all warranty rights.

- **Make sure the voltage of each PV array is less than 1500V at all times. Permanent damage may occur otherwise.**
- **Make sure the max. short-circuit current of the DC side is within the permissible range. Permanent damage may occur otherwise.**

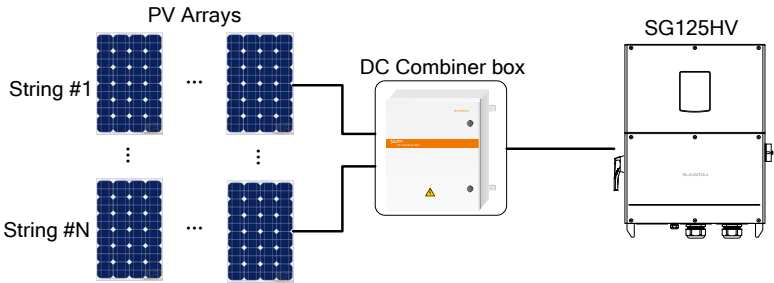

NOTICE

The SG125HV/SG125HV-20 is a single stage inverter with only one MPPT. To make full use of the DC input power and reduce the power loss caused by mismatch, the type and rating of the PV modules connected to one inverter should be the same, including:

- the same PV module model;
- the same number of PV modules;
- the same angle of tilt of the PV modules;

6.3.2 PV Input Connection

NOTICE

During the PV string input connection, the DC current of each string should be gathered together by a combiner box (or other combining devices) and then connected to the inverter.

DC Cable Requirements

Select DC cables according to the following factors:

- The maximum operating temperature of the cable should no less than 90° C(+194°F).

- The current rating of the cable should be selected in accordance with the maximum short circuit current of the PV arrays connected to the inverter.
- The voltage rating of the cable should no less than 1500V.
- The Conductor type can be copper wire or aluminum wire.
- If the aluminum cable is selected, in order to ensure a reliable electrical connection, use the albronz filter or the copper and aluminum conversion terminal to avoid direct contact between the DC copper bar and the aluminum cable.

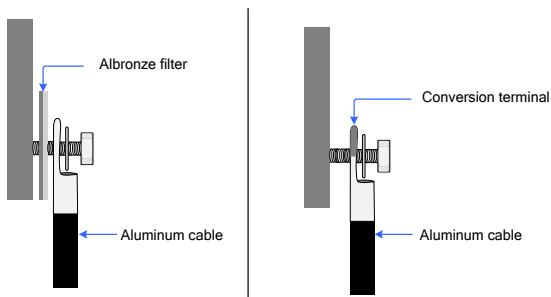

Beware the direction of the albronz filter, i.e. the copper side must be closely attached to the copper bar and the aluminum side must be closely attached to the aluminum connection terminal.

NOTICE

The device may be damaged or operate abnormally if the aluminum cable is directly connected to the copper bar.

- The DC cable must be selected in accordance with the local installation requirements.
- The range of DC cables is: 70mm²-185 mm²(AWG2/0-350Kcmil).

DC Cable Connection

⚠ DANGER

High voltage inside the inverter!

Make sure all DC and AC cables connected to the inverter are voltage-free before electrical connection.

Do not connect the AC circuit breaker before electrical connection is completed.

Step 1 Rotate the DC switch to the "OFF" position.

Step 2 Strip the insulation layer of the DC cable to proper length according to the DC cable specification.

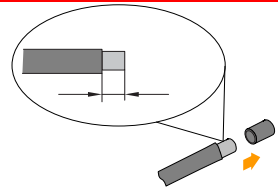

Step 3 Insert the end of the DC cable to the cable socket that matches with the M10 bolt and tighten it with the proper tool.

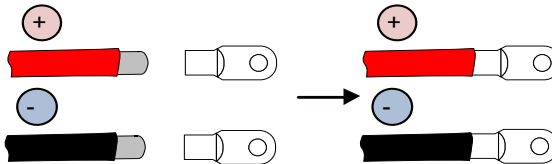

Step 4 Install the heat-shrinkable tubing, shrink the tubing with hot air blower.

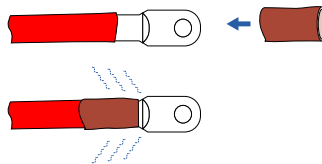

Step 5 Connect the positive and negative polarity of the DC cable to the corresponding positive and negative cable connection terminals.

* For torque specifications, refer to 11.2 Tightening Torques.

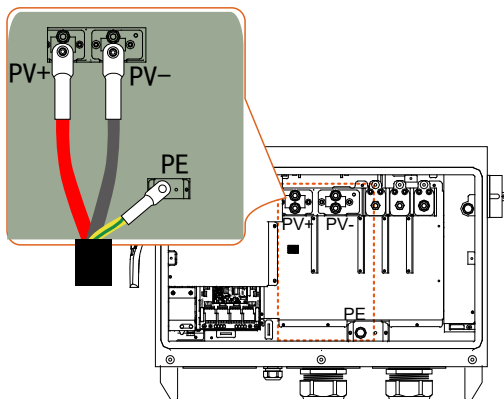

⚠ WARNING

- **When accessing the positive and negative cable, it is necessary to ensure the insulation requirements between the positive access and the negative access. Once positive and negative inputs are short-circuited, it can cause unrecoverable damage to the inverter. Sungrow shall hold no liability for any possible consequences caused by ignorance of this warning.**

NOTICE

- **Check the positive and negative polarity of the PV cells. After confirmation, you can insert the DC connectors into the input terminals on the bottom of the inverter.**
- **For the connection to the same MPPT, reversing the polarity of a single string is prohibited. A permanent failure of the system or inverter may occur.**

Step 6 Pull the cable gently to make sure it is secured.

Step 7 Connect other PV strings following the above-mentioned procedures.

Step 8 Seal the gaps between the DC cable and the gland inside the lower part of the cabinet with duct seal.

NOTICE

Seal the gap between the cable and the gland/conduit with duct seal or other suitable materials to prevent the entry of foreign bodies or

moisture and ensure long-term and normal operation of the inverter.

6.4 Grounding the Inverter

WARNING

Due to the transformer-less design of the inverter, neither the DC positive pole nor the DC negative pole of the PV string can be grounded.

6.4.1 Grounding System Overview

In this PV system, all non-current carrying metal parts and device enclosure should be grounded (such as the PV array frame and inverter enclosure).

When there is only one inverter in the PV system, ground the PE cable.

When there are multiple inverters in the PV system, they can be multi-point grounded. Connect PE cables of all inverters and the mounting metal frames of PV array to the equipotential cable (according to the on-site conditions) to implement an equipotential connection.

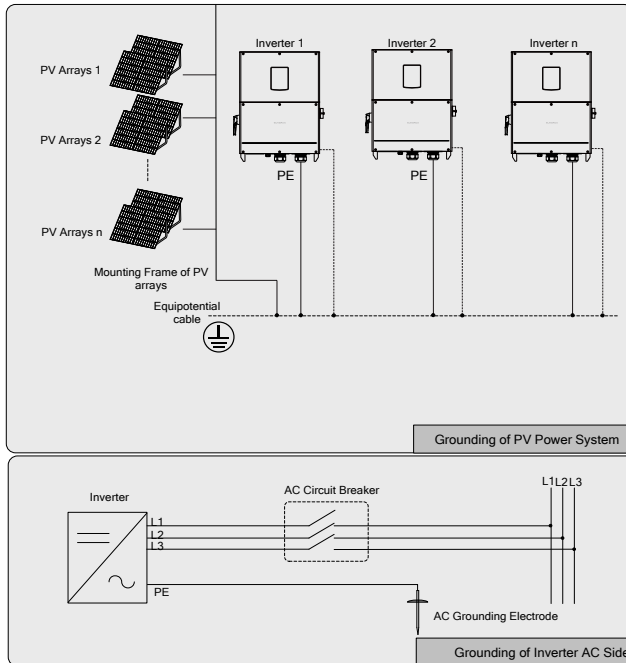

Fig. 6-5 Grounding of inverter

6.4.2 Second Protective Earth Terminal

Position of Second PE Terminals

There is a second PE terminal on one side of the inverter and it should be grounded.

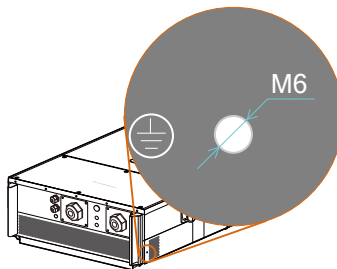

Fig. 6-6 Second PE terminal

WARNING

The connection of second PE terminal is optional. Whether to connect the terminal is determined according to local standards or regulations, but connection is recommended.

Cable Connection

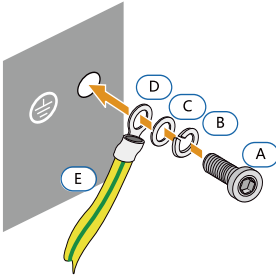

Fig. 6-7 Second PE connection

* Connection parts are not within the scope of delivery

* For torque specifications, refer to 11.2 Tightening Torques.

Item	Name	Description
A	Screw	M6×12mm
B	Lock washer	-
C	Washer	-
D	Cable socket	-
E	Grounding cable*	-

*the cross-sectional area of the grounding cable should not be less than half of the PE cable of the AC cable.

6.5 RS485 Communication Connection

6.5.1 Communication Overview

There are two communication waterproof connection terminals on the bottom of the inverter. RS485 A/B terminals and RS485 interface are provided on the configuration circuit board of the junction box. A 120Ω terminating resistor can be connected between the A and B communication cable through the dip switch.

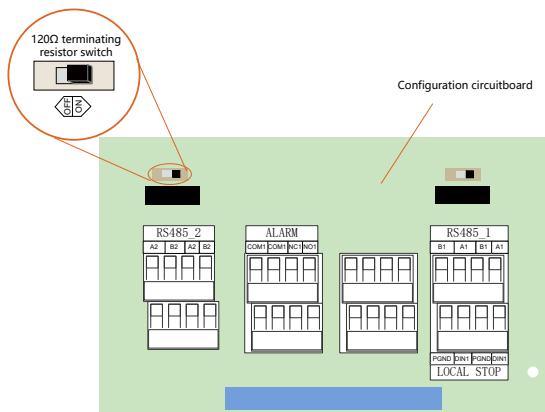

Fig. 6-8 Communication configuration

The inverter operation information can be transferred to the PC of the installed monitoring software or to a local data logging device through RS485 communication connection.

Prepare communication cable before communication connection.

NOTICE

**RS485 communication cables should be:
Shielded twisted pair cables or Shielded twisted pair Ethernet cable.**





A converter such as Data Logger is needed to convert signal between inverter and PC.

6.5.2 RS485 Communication System

For Single Inverter

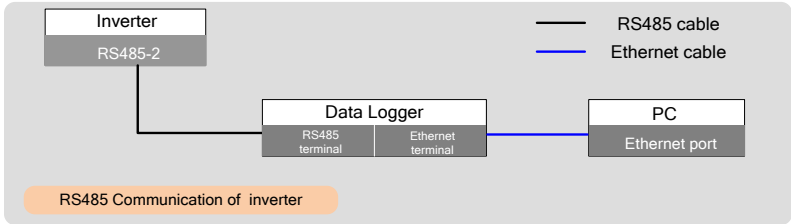
Where there is only one inverter, an RS485 cable can guarantee the communication connection.

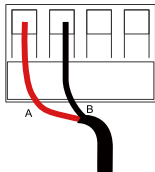
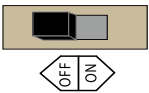

Inverter	Communication connection (RS485 bus)	Terminating Resistor
Single inverter	Only out 	No 120ohm  

For Multiple Inverters

Where there is more than one inverter, all inverters can be connected in a daisy chain through an RS485 communication cable. The shielding layer of the RS485 cable should be single-point grounded.



- The length of an RS485 communication cable should be less than 1200m.
- If several inverters communicate with each other and connect to the Logger 3000, at most 4 daisy chains are supported and 60 devices in total can be connected (i.e. 4 daisy chains can be connected with at most 15 devices connected to one chain or 3 daisy chains are connected with at most 20 devices connected to one chain).

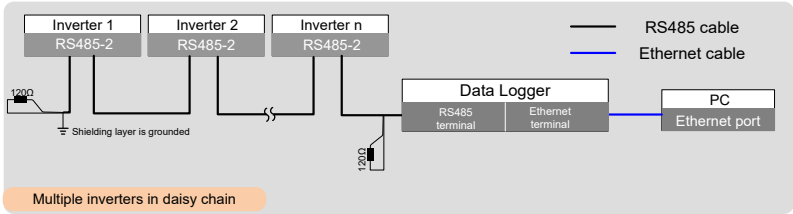

Inverter	Communication connection (RS485 connection)	Terminating Resistor	
		$n \leq 15$	$n > 15$
Inverter 1	Only out 	No 	Yes 120ohm
Inverter 2~n-1	In and Out 	No 	
Inverter n	In and Out 	No 120ohm 	Yes 120ohm

6.5.3 RS485 Communication Connection

RS485A/B Bus Connection

Step 1 Thread the Network cable through communication cable gland to the configuration circuit board.

Step 2 Strip off the insulation layer of the communication cable. Connect the A and B of RS485 communication cable to corresponding terminals according to the marks on the configuration circuit board.

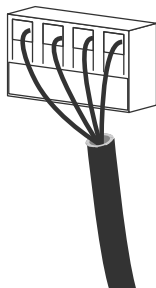

Step 3 According to the position of the inverter (refer to the prior section), repeat step 1...2 to connect the other RS485 cables.

Step 4 Lightly pull on cables to confirm whether they are fastened firmly.

Step 5 According to the position of the inverter (refer to the prior section), switch the terminating resistor ON or OFF.

Step 6 Tighten the thread-lock sealing lock. Block off the vacant terminals to protect from dust and moisture penetrating inside the inverter.

Step 7 Seal the gaps between the cable and the gland inside the lower part of the cabinet with duct seal. If there is no other connection procedure, reassemble and connect the front cover of the connection cabinet.

NOTICE

Seal the gap between the cable and the gland with duct seal or other suitable materials to prevent the entry of foreign bodies or moisture and ensure long-term and normal operation of the inverter.

Step 8 Connect the communication devices. Refer to other manuals and documents if there are other devices.

Step 9 Confirm the communication connection and set the communication parameters.



If more than one inverter is connected to PC or Logger, please set the communication parameters from the APP interface.



Logger 3000 is optional parts and can be ordered from Sungrow.

6.6 Configurable Dry Contact

There are Fault Alarm dry contacts and Local Stop dry contacts located on the configurable circuit board.

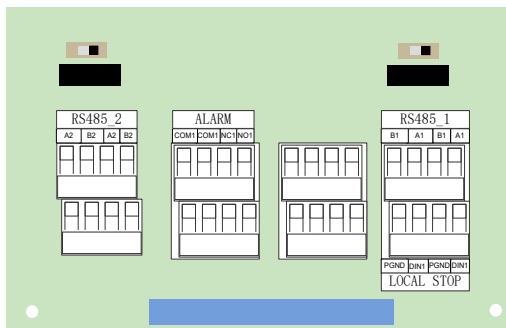

Fault Alarm dry contacts

The dry contacts can be configured as fault alarm. When the inverter is running normally, the two terminals NC&COM are short-circuited. when a fault occurs, the two terminals NC&COM are break out. The two terminals NO&COM are opposite.

NOTICE

The cross-section area range of dry contact’s cable is 28AWG...16AWG.

The devices to be connected to the dry contacts must comply with the related requirements:

AC Requirements	DC Requirements
Max. Voltage: 250Vac	Max. Voltage: 30Vdc
Max. Current: 5A	Max. Current: 5A

Local Stop dry contacts

The dry contacts can be configured as Local Stop. When the two terminals PGND & DIN1 are short-circuited, the inverter will stop running immediately. In this case, if the two terminals PGND & DIN1 are disconnected, the inverter will return to the previous state.



The dry contacts only support passive switch signal input.

- Multiple inverters connected in a daisy chain topology

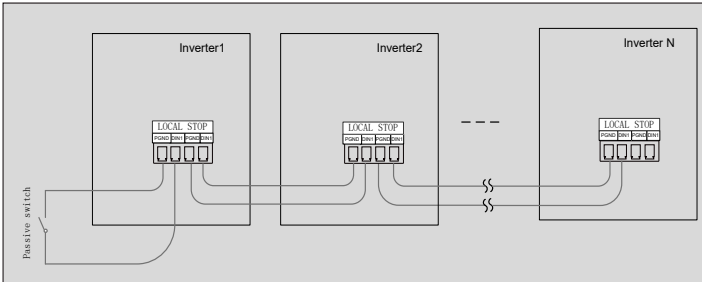

Fig. 6-9 Multiple inverters connected in a daisy chain topology

- Multiple inverter Master-slave mode connection in an RS485 daisy chain

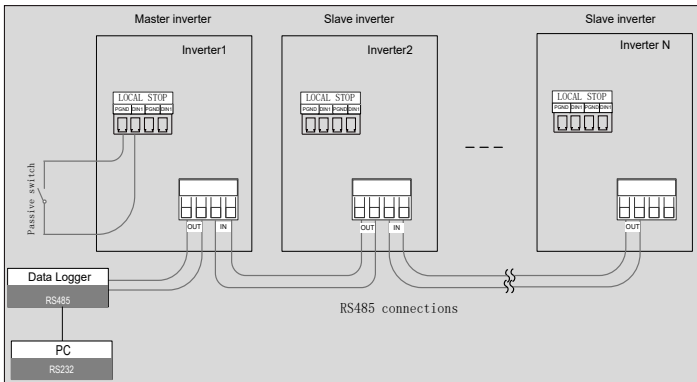

Fig. 6-10 Multiple inverter Master-slave mode connection



The inverter with a direct connection to the data logger is automatically set to the master inverter. It sends Stop instructions to other inverters via RS485 communications.

7 Commissioning

Commissioning is a critical procedure for a PV system, which can protect the system from fires, and personnel from injury and electrical shock.

7.1 Inspection before Commissioning

Before starting the inverter, you should check the following items.

1. The inverter should be accessible for operation, maintenance and service.
2. Check again to confirm that the inverter is firmly installed.
3. Proper ventilation.
4. The inverter is clean and free of debris.
5. The inverter and accessories are correctly connected.
6. Cables are routed safely place and protected against mechanical damage.
7. The specification of the AC circuit breaker is appropriate for its intended use.
8. The terminals not used underneath the inverter should be sealed.
9. Warning signs & labels are suitably affixed and durable.

7.2 Commissioning Procedure

If all of the items mentioned above meet the requirements, proceed as follows to start up the inverter for the first time.

Step 1 Make sure all the above-mentioned items meet the requirements.

Step 2 Close the external AC circuit breaker.

Step 3 Rotate the DC switch to the "ON" position.

Step 4 Use the SunAccess App to establish the communication connection with the inverter through Bluetooth to set the initial parameters. When the

device is initialized, send start instructions via the App For details, please refer to "10.3 Logging SunAccess APP".

Provided there is sufficient sunlight:

- PV arrays initialize and supply DC power to inverter;
- DC-link starts to charge and check the state of the utility grid;
- If the conditions are OK, the inverter feeds AC power to the grid and enters into the running state.

Step 5 Observe the status of LED indicator panel (Refer to Tab. 2-2LED indicator description).

8 Disconnecting, Dismantling and Disposing the Inverter

8.1 Disconnecting the Inverter

For maintenance work or any service work, the inverter must be switched off. During normal operation, the inverter should remain switched on.

Proceed as follows to disconnect the inverter from DC and AC power sources

Step 1 Disconnect the external AC circuit breaker or disconnect to prevent it from accidentally reconnecting to the utility grid.

Step 2 Rotate the DC switch to the "OFF" position and then disconnect all of the PV string inputs

NOTICE

Please strictly adhere to the above sequence. The inverter may be damaged otherwise.

Step 3 Wait about ten minutes until the capacitors inside the inverter have been discharged.

Step 4 Loosen the six screws on the lower connection cabinet and then remove the lid.

Step 5 Measure the AC voltage to ground at the AC terminal to confirm AC output voltage of inverter at the AC circuit breaker is zero.

Step 6 Remove the AC cables.

Step 7 Remove the DC cables.

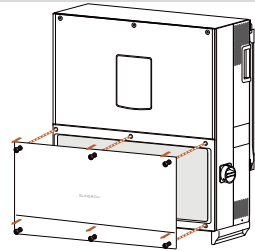

8.2 Dismantling the Inverter

Refer to Chapter 5 and Chapter 6 to dismantle the inverter in reverse steps.

NOTICE

If the inverter will be reinstalled in the future, please refer to “4.4 Inverter Storage” for a proper storage.

8.3 Disposal of the Inverter

System owners and the O&M company are responsible for the disposal of the inverter.

NOTICE

Some parts and devices in the inverter, such as the LED indicator panel, batteries, modules and other components, may cause environmental pollution. Disposal of the inverter must comply with the related local regulations to avoid pollution.

9 Troubleshooting and Maintenance

9.1 Troubleshooting

Once a fault occurs in the inverter, the fault information can be displayed on the APP interface or the LCD.

Fault codes and check methods are as follows:

Fault code	Description	Check method
002	Grid overvoltage, The grid voltage is higher than the set protection value.	Generally, the inverter will be reconnected to the grid after the grid returns to normal. If the fault occurs repeatedly: 1. Measure the actual grid voltage, and contact the local electric power company for solutions if the grid voltage is higher than the set value. 2. Check whether the protection parameters are appropriately set via the APP or the LCD. 3. Check whether the cross-sectional area of the AC cable meets the requirement. 4. If the fault is not caused by the foregoing reasons and still exists, contact Sungrow Service.
003	Transient overvoltage, The transient grid voltage is higher than the standard value.	Generally, the inverter will be reconnected to the grid after the grid returns to normal. If the fault occurs repeatedly, contact Sungrow Service.

Fault code	Description	Check method
004-005	Grid undervoltage, The grid voltage is lower than the set protection value	<p>Generally, the inverter will be reconnected to the grid after the grid returns to normal. If the fault occurs repeatedly:</p> <ol style="list-style-type: none"> 1. Measure the actual grid voltage, and contact the local electric power company for solutions if the grid voltage is lower than the set value. 2. Check whether the protection parameters are appropriately set via the APP or the LCD. 3. Check whether the AC cable is firmly in place. 4. If the fault is not caused by the foregoing reasons and still exists, contact Sungrow Service.
006-007	AC output current exceeds the upper limit of the inverter.	<p>Generally, the inverter will be reconnected to the grid after the grid returns to normal. If the fault occurs repeatedly, contact Sungrow Service.</p>
008	Grid overfrequency, Grid frequency exceeds the upper limit of the inverter.	<p>Generally, the inverter will be reconnected to the grid after the grid returns to normal. If the fault occurs repeatedly:</p>
009	Grid underfrequency, Grid frequency is lower than the lower limit of the inverter.	<ol style="list-style-type: none"> 1. Measure the actual grid frequency, and contact the local electric power company for solutions if the grid frequency is beyond the set range. 2. Check whether the protection parameters are appropriately set via the APP or the LCD. 3. If the fault is not caused by the foregoing reasons and still exists, contact Sungrow Service.

Fault code	Description	Check method
010	AC power failure, AC switch or circuit is disconnected.	<p>Generally, the inverter will be reconnected to the grid after the grid returns to normal. If the fault occurs repeatedly:</p> <ol style="list-style-type: none"> 1. Check whether the grid supplies power reliably. 2. Check whether the AC cable is firmly in place. 3. Check whether the AC cable is connected to the correct terminal (whether the live wire and the N wire are correctly in place). 4. Check whether the AC circuit breaker is connected. 5. If the fault is not caused by the foregoing reasons and still exists, contact Sungrow Service.
011	DC component in the AC current exceeds the permissible range of the inverter.	<ol style="list-style-type: none"> 1. The fault is caused by external fault of the inverter. Generally, the inverter will be reconnected to the grid after the external fault is removed. 2. If the fault occurs repeatedly, contact Sungrow Service.
012	Excessive current leakage	<ol style="list-style-type: none"> 1. The fault can be caused by poor sunlight or damp environment, and the inverter will be reconnected to the grid after the environment is improved. 2. If the environment is normal, check whether the AC and DC cables are well insulated. 3. If the fault is not caused by the foregoing reasons and still exists, contact Sungrow Service.

Fault code	Description	Check method
013	The grid voltage or frequency is out of the permissible range, and the inverter cannot be connected to the grid normally.	<p>Generally, the inverter will be reconnected to the grid after the grid returns to normal. If the fault occurs repeatedly:</p> <ol style="list-style-type: none"> 1. Measure the actual grid frequency, and contact the local electric power company for solutions if the grid parameter exceeds the set value. 2. If the fault is not caused by the foregoing reasons and still exists, contact Sungrow Service.
014	The grid voltage exceeds the preset AC voltage of the inverter for a long time.	<p>Wait for the inverter to return to normal. If the fault occurs repeatedly, contact Sungrow Service.</p>
015	Grid overvoltage, The grid voltage is higher than the set protection value	<p>Generally, the inverter will be reconnected to the grid after the grid returns to normal. If the fault occurs repeatedly:</p> <ol style="list-style-type: none"> 1. Measure the actual grid voltage, and contact the local electric power company for solutions if the grid voltage is higher than the set value. 2. Check whether the protection parameters are appropriately set via the APP or the LCD. 3. Check whether the cross-sectional area of the AC cable meets the requirement. 4. If the fault is not caused by the foregoing reasons and still exists, contact Sungrow Service.
016	Output overload, The configured module power is excessively large and out of the normal operation range of the inverter.	<p>Wait for the inverter to return to normal. If the fault still exists, contact Sungrow Service.</p>

Fault code	Description	Check method
017	The inverter detects unbalanced three-phase voltage	Generally, the inverter will be reconnected to the grid after the grid returns to normal. If the fault occurs repeatedly, contact Sungrow Service.
019-020	Excessively high bus voltage	Generally, the inverter will be reconnected to the grid after the bus voltage returns to normal. If the fault occurs repeatedly: 1. Check the PV voltage via the APP or the LCD. If the PV voltage exceeds the maximum permissible voltage, it indicates that the PV module configuration is too high and needs to be optimized. 2. If the fault is not caused by the foregoing reasons and still exists, contact Sungrow Service.
021-022	The inverter detects input overcurrent of the modules	Wait for the inverter to return to normal. Disconnect the AC and DC switches, and reconnect the AC and DC switches 15 minutes later to restart the inverter. If the fault still exists, contact Sungrow Service.
024-026 030-034	Device anomaly	Wait for the inverter to return to normal. Disconnect the AC and DC switches, and reconnect the AC and DC switches 15 minutes later to restart the inverter. If the fault still exists, contact Sungrow Service.
036-037	Temperature anomaly, The temperature of the power module or the interior of the inverter is excessively high and out of the safe range.	1. Check whether the inverter is directly exposed to sunlight. If so, take some shading measures. 2. Check and clean the air ducts. 3. Check whether there is 070 (fan anomaly) alarm via the APP or the LCD. If so, replace the fans.

Fault code	Description	Check method
038	Device anomaly	<p>Wait for the inverter to return to normal.</p> <p>Disconnect the AC and DC switches, and reconnect the AC and DC switches 15 minutes later to restart the inverter. If the fault still exists, contact Sungrow Service.</p>
039	Low insulation resistance, which is generally caused by poor insulation to ground of the module/cable or by rainy and damp environment.	<p>Wait for the inverter to return to normal. If the fault occurs repeatedly:</p> <ol style="list-style-type: none"> 1. Check whether the ISO resistance protection value is excessively high via the APP or the LCD, and ensure that it complies with the local regulations. 2. Check the resistance to ground of the string and DC cable. Take correction measures in case of short circuit or damaged insulation layer. 3. If the cable is normal and the fault occurs on rainy days, check it again when the weather turns fine. 4. If the fault is not caused by the foregoing reasons and still exists, contact Sungrow Service.
040-042	Device anomaly	<p>Wait for the inverter to return to normal.</p> <p>Disconnect the AC and DC switches, and reconnect the AC and DC switches 15 minutes later to restart the inverter. If the fault still exists, contact Sungrow Service.</p>
043	The ambient temperature is lower than the temperature at which the inverter can operate normally.	<p>Stop and disconnect the inverter. Restart the inverter when the ambient temperature falls within the operation temperature range.</p>
044-045	Device anomaly	<p>Wait for the inverter to return to normal.</p> <p>Disconnect the AC and DC switches, and reconnect the AC and DC switches 15 minutes later to restart the inverter. If the fault still exists, contact Sungrow Service.</p>

Fault code	Description	Check method
047	PV input mode error	Stop and disconnect the inverter. Reset the input mode of the PV array.
048-051 053-060	Device anomaly	Wait for the inverter to return to normal. Disconnect the AC and DC switches, and reconnect the AC and DC switches 15 minutes later to restart the inverter. If the fault still exists, contact Sungrow Service.
070	Fan fault	1. Check whether the fans operate normally and are blocked by sundries. If they are blocked, clear the sundries. 2. If a fan does not operate normally, stop and disconnect the inverter to replace the fan.
071	AC SPD fault	Check the SPD, and replace it if necessary.
072	DC SPD fault	
073	Device anomaly	Wait for the inverter to return to normal. Disconnect the AC and DC switches, and reconnect the AC and DC switches 15 minutes later to restart the inverter. If the fault still exists, contact Sungrow Service.
074	Internal communication anomaly, A fault occurs in the internal communication module of the inverter.	Contact Sungrow Service.
075-077	Device anomaly	Wait for the inverter to return to normal. Disconnect the AC and DC switches, and reconnect the AC and DC switches 15 minutes later to restart the inverter. If the fault still exists, contact Sungrow Service.

Fault code	Description	Check method
078-081	Device anomaly	Wait for the inverter to return to normal. Disconnect the AC and DC switches, and reconnect the AC and DC switches 15 minutes later to restart the inverter. If the fault still exists, contact Sungrow Service.
087	AFD module anomaly	1. Check whether the cable connection on the DC side is normal, and take correction measures if necessary. 2. If the fault is not caused by the foregoing reasons and still exists, contact Sungrow Service.
088	Electric arc fault	
089	AFD disable alarm	Restart the inverter or clear the fault through the App. If the fault still exists, contact Sungrow Service.
105	Protection self-check failure on grid side	1. Check whether the AC cable is correctly connected. 2. Check whether the insulation between the ground cable and the live wire is normal. 3. If the fault is not caused by the foregoing reasons and still exists, contact Sungrow Service.
106	Grounding anomaly	Wait for the inverter to return to normal. Disconnect the AC and DC switches, and reconnect the AC and DC switches 15 minutes later to restart the inverter. If the fault still exists, contact Sungrow Service.
116-117	Device anomaly	Wait for the inverter to return to normal. Disconnect the AC and DC switches, and reconnect the AC and DC switches 15 minutes later to restart the inverter. If the fault still exists, contact Sungrow Service.

Fault code	Description	Check method
532-547	Reverse string polarity	<p>1. Check whether the corresponding string is of reverse polarity. If so, disconnect the DC switch and adjust the polarity when the solar radiation is low and the string current drops below 1A.</p> <p>2. If the fault is not caused by the foregoing reasons and still exists, contact Sungrow Service.</p> <p>*The code 532 to code 547 are corresponding to string 1 to string 16 respectively.</p>
548-563	String output current anomaly	<p>1. Check whether the corresponding module is sheltered. If so, remove the shelter and ensure module cleanness.</p> <p>2. Check the module for abnormal aging.</p> <p>3. If the fault is not caused by the foregoing reasons and still exists, contact Sungrow Service.</p> <p>*The code 548 to code 563 are corresponding to string 1 to string 16 respectively.</p>
564-565	Reverse string polarity	<p>1. Check whether the corresponding string is of reverse polarity. If so, disconnect the DC switch and adjust the polarity when the solar radiation is low and the string current drops below 1A.</p> <p>2. If the fault is not caused by the foregoing reasons and still exists, contact Sungrow Service.</p> <p>*The code 564 and code 565 are corresponding to string 17 and string 18 respectively.</p>

Fault code	Description	Check method
580-581	String output current anomaly	1. Check whether the corresponding module is sheltered. If so, remove the shelter and ensure module cleanliness. 2. Check the module for abnormal aging. 3. If the fault is not caused by the foregoing reasons and still exists, contact Sungrow Service. *The code 580 and 581 are corresponding to string 17 and string 18 respectively.

9.2 Maintenance

9.2.1 Routine Maintenance

Item	Method	Period
System clean	Check the temperature and dust of the inverter. Clean the inverter enclosure if necessary. Check if the air inlet and outlet are normal. Clean the air inlet and outlet, if necessary.	Six months to a year (depend on the dust contents in air.)
Fans	Check whether there is fan warning using APP. Check whether there is any abnormal noise when the fan is turning. Clean or replace the fans if necessary (see the following section).	Once a year
SPD	Check whether there is SPD warning using APP. Replace the AC SPD and DC SPD (contact Sungrow) whenever necessary.	Every six months

9.2.2 Maintenance Instruction

Fan Maintenance

Fans inside the inverter are used to cool the inverter during operation. If the fans do not operate normally, the inverter may not be cooled down and inverter

efficiency may decrease. Therefore, it is necessary to clean the dirty fans and replace the broken fans in time.

⚠ DANGER

Stop the inverter and disconnect it from all power supplies before maintenance.

Lethal voltage still exists in the inverter even after the inverter has been switched off and disconnected. Please wait for at least ten minutes and then perform maintenance work.

Only qualified electricians can maintain the fans.

Step 1 Disconnect the AC Switch.

Step 2 Rotate the DC switch to the "OFF" position.

Step 3 Wait for at least ten minutes.

Step 4 Disconnect all electrical connection in the reverse procedures in the "6 Electrical Connection".

Step 5 Unscrew the bolts as shown in the right picture.

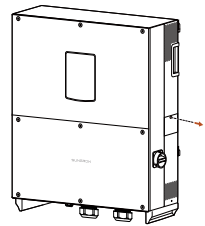

Step 6 Clasp the groove (near the cover plate of the fan) on the back of the inverter by your fingers and pull out the slot of the fan.

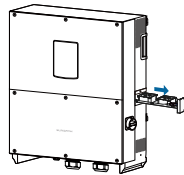

Step 7 Press the hump of the latch hook and unplug the cable connection joint outwards.

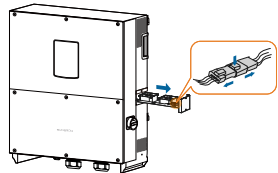

Step 8 当侧面距离不够时 (400~600mm) ,可将风扇导轨中间的螺钉拆掉, 先卸下第一节风扇。

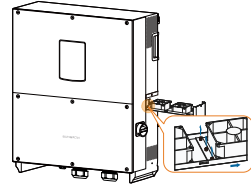

Step 9 Remove all the fans from the inverter.

Step 10 Clean the fan with soft brush or vacuum cleaner, or replace the broken fans.

Step 11 Reassemble the fans back into the inverter and restart the inverter.

Cleaning Air Inlet and Outlet

A huge amount of heat is generated in the process of running the inverter. The inverter adopts a controlled forced-air cooling method.

In order to maintain good ventilation, please check to make sure the air inlet and outlet are not blocked.

Clean the air inlet and outlet with soft brush or vacuum cleaner if necessary.

10 SunAccess APP

10.1 Introduction to the System

By establishing a communication connection with the inverter through Bluetooth, the SunAccess APP can access near-end maintenance to the inverter. You can check the running info, alarms and events, set the parameters, download the logs and update the firmware through the APP.

10.2 Acquire and install SunAccess APP

The SunAccess APP is available in iOS and Android versions. You can download corresponding versions according to the operating system of your phone.



This manual will utilize the iOS version to introduce the installation and use of SunAccess APP. These steps are the same for the Android version. The pictures in this document are indicative only since the app version may be upgraded later. Please refer to the actual interface of the app.

10.2.1 Installation Condition

- Required phone operating system: iOS 9.3 and above  for iPhones; Android 5.1 and above for Android phones
- Recommended iPhone models: iPhone5s and above
- Ensure that the phone has enough memory to install the app
- Ensure the phone is fully charged

10.2.2 Operation Steps

Step 1 Download the SunAccess APP installation package.

- a) For iOS version: search for the SunAccess in the App Store; download and

install the app according to the tips of the interface.

- b) For Android: search for the SunAccess in Myapp or Google Play; download and install the app according to the instructions.

Step 2 Click "Open" after the app is installed to open the app. You can also open the app by clicking the icon of the app on your phone desktop.



Fig. 10-1 SunAccess



You can also scan the QR code on the right side of the inverter cabinet to download and install according to the instructions.

10.3 Log into SunAccess APP



During the use of the SunAccess APP, make sure your phone is within 5m from the inverter and there are no barriers between your phone and the inverter. The communication quality cannot be ensured otherwise.

Step 1 Click the mobile phone APP icon to enter the Bluetooth search interface. Select the inverter to be connected according to the serial number on the nameplate on the side of the fuselage. The blue light on the LED panel indicates that the connection is successful.

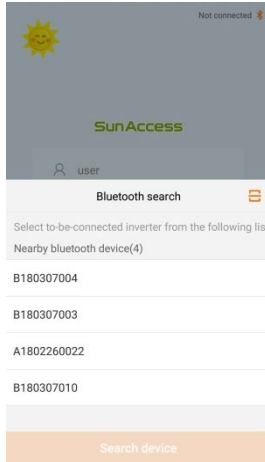

Step 2 Select the Bluetooth device to be connected according to the serial number on the nameplate attached to the inverter side, and establish the connection.

Step 3 Default username: user. Input the password 111111 and click Login.

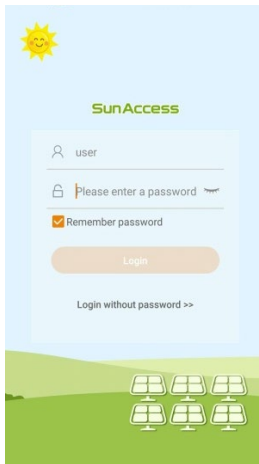

Fig. 10-2 Login



If you have no password, please click "login without password" to log in and check certain info.

Step 4 If the inverter is not initialized, you will enter the initialization protection parameter quick setting interface as shown in Fig. 10-3 after the Bluetooth is connected. After setting the quick setting interface, click “Save” and the device will be initialized. The App will send start instructions and the device will start and operate.

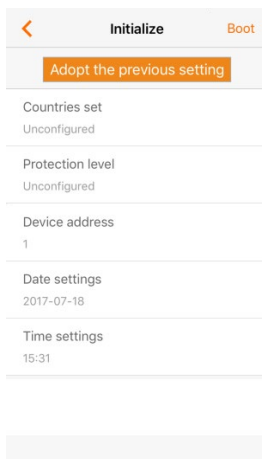

Fig. 10-3 Initialization protection parameter



The system interface may be different for different types of users. If you login by “login without password”, the app will not show the initialization protection parameter setting interface.

The regular user can only set the country, instructions (valid for certain countries) and protection stage. The country code stands for the protection parameter of the corresponding location and has been set before delivery.

⚠ CAUTION

If the country code is not set correctly during commissioning, reset the protection parameters. There may be faults unless this is done.

If the inverter is initialized, the app automatically turns to its homepage as shown in Fig. 10-4 when the Bluetooth is connected.

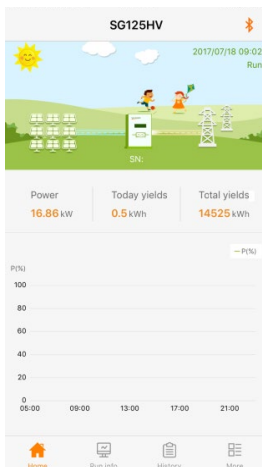

Fig. 10-4 Homepage

10.4 Homepage

Step 1 Click the “Home” icon from the navigation bar;

Step 2 The homepage with the power, power yields, and real-time alarm info will appear as shown in Fig. 10-5.

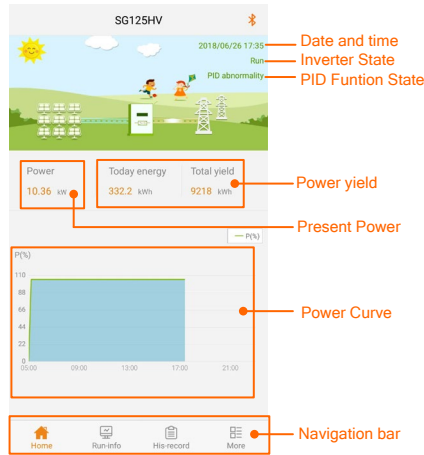

Fig. 10-5 Check the homepage info

Tab. 10-1 Description of inverter state

State	Description
Run	After being energized, inverter tracks the PV arrays' maximum power point (MPP) and converts the DC power into AC power. This is the normal operation mode.
Stop	Inverter is stopped.
Initial standby	The inverter is in the initial power-on standby state
Standby	Inverter enters standby mode when DC side input is insufficient. In this mode inverter will wait within the standby duration.
Key-stop	Inverter will stop operation by manually "stop" via SunAccess app. In this way, inverter internal DSP stops. To restart the inverter, manually start via SunAccess app.
Starting	The inverter is initializing and synchronizing with the grid.
Derating running	The inverter derates actively due to environmental factors such as temperature or altitude
Fault	If a fault occurs, inverter will automatically stop operation, disconnect the AC relay. The fault information will be displayed in the SunAccess app. Once the fault is removed in recovery time, inverter will automatically resume running.
Warning	Warning information is detected.
Scheduling running	The inverter runs according to the scheduling instructions received from the monitoring background

Tab. 10-2 Description of PID function state

State	Description
PID recovery running	The inverters perform PID recovery actively.
PID protection running	The inverter is suppressing the PID effect.
PID abnormality	It is detected that the ISO impedance is abnormal or the PID function cannot work normally after the PID function enabled.
PID standby	The PID function is enabled, but regulation is not performed actually and no abnormality is detected.



If a real-time alarm occurs in the inverter, there will be an alarm or fault icon appearing in the lower right corner of the inverter (circled by a box in the top of the interface). You can click this icon to get the detailed alarm or fault info.

10.5 Run Info

Step 1 Click the “Run Info” icon from the navigation bar.

Step 2 The run info includes the input, output, string, grid voltage, grid current, environment, and other info as shown in Fig. 10-6. You can swipe up and down to check the corresponding info.

Run info		Run info	
Input		Grid voltage	
Total DC power (kW)	16.99	B-C line voltage (V)	579
DC voltage 1 (V)	855	C-A line voltage (V)	577
DC current 1 (A)	19.8	Grid current	
Output		A phase current (A)	22.1
AC frequency (Hz)	50.02	B phase current (A)	22.1
Total active power (kW)	16.88	C phase current (A)	22.2
Apparent power (kVA)	21.45	Environment	
Monthly generating capacity (kWh)	4836	Inner temperature (°C)	389
Grid voltage		Other	
A-B line voltage (V)	579	In parallel resistance to ground (kΩ)	2636
B-C line voltage (V)	579	Countries info	Other 50Hz
C-A line voltage (V)	577	Command info	50Hz

Fig. 10-6 Run info

Tab. 10-3 Description of Running Parameters

Parameter	Description	
Input	Total DC power (kW)	the total PV input power
	DC voltage(V)	the input voltage
	DC current(A)	the input current
Output	AC frequency (Hz)	-
	Total active power (kW)	-
	Apparent power(kVA)	-
Grid voltage	Monthly generating capacity(kWh)	The energy generated in this month
	A-B line voltage (V)	Line voltage
	B-C line voltage (V)	
Grid current	C-A line voltage (V)	Phase current
	A phase current (A)	
	B phase current (A)	
Environment	C phase current (A)	Internal temperature of the inverter
	Inner temperature (°C)	

Parameter	Description	
In parallel resistance to ground (kΩ)	-	
Other	Countries info	Inverter selected country code
	Command info	Inverter selected command information

10.6 History Record

Click the “History” icon from the navigation bar to view the history record interface as shown in Fig. 10-7. You can check the alarm records, power yield records and event records.

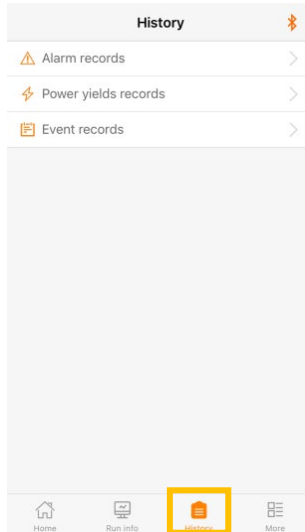

Fig. 10-7 History record

10.6.1 Fault Alarm Records

Step 1 Click the “Alarm Records” to check the alarm records as shown in Fig. 10-8.

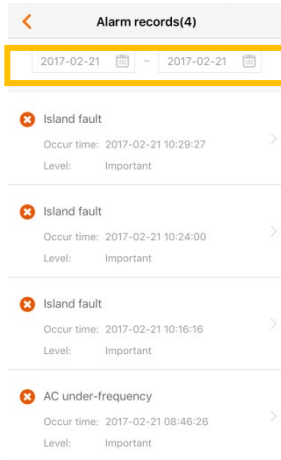

Fig. 10-8 Fault alarm records



If you need to check the alarm records within a certain period of time, please click the time selection bar on the top of the interface to select a certain period of time. The inverter can at most, record the latest 100 fault alarm instances.

Step 2 Select one of the records in the list and click the record, to view the detailed fault info as shown in Fig. 10-9.



Fig. 10-9 Detailed fault alarm info

10.6.2 Power Yields Records

User can view various energy records: power curve, daily energy histogram, daily energy histogram, monthly energy histogram, and annual energy histogram.

Tab. 10-4 Explanation of power yields records

Parameter	Description
Power curve	Show the power output from 5 am to 11 pm in a single day. Each point in the curve is the percentage of present power and nominal power.
Daily energy histogram	Shows the power output every day in the present month.
Monthly energy histogram	Shows the power output every month in a year.
Annual energy histogram	Shows the power output every year.

Step 1 Click the “Power Yields Records” to view the power curve page as shown in Fig. 10-10.

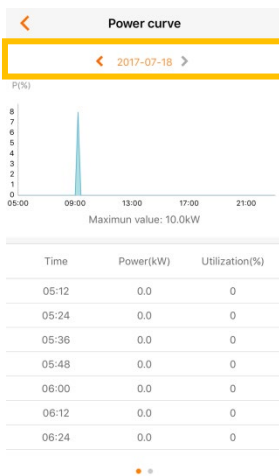

Fig. 10-10 Power curve

Step 2 Click the time selection bar on the top of the interface to check the power curve of a certain time as shown in Fig. 10-11.

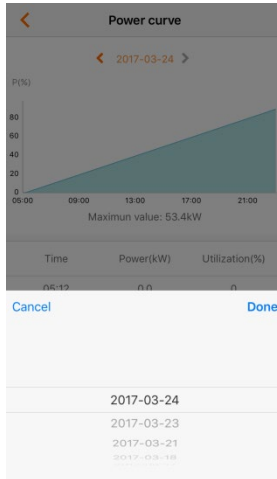

Fig. 10-11 Power curve

Step 3 Swipe left to check the power yields histogram as shown in Fig. 10-12.

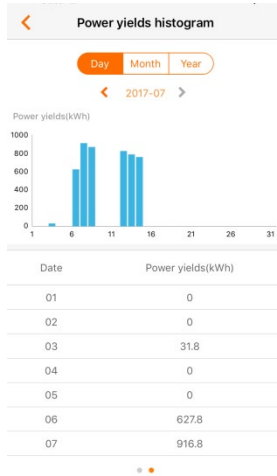

Fig. 10-12 power yields histogram

10.6.3 Event Records

Click the "Event records" to check the event record list as shown in Fig. 10-13.

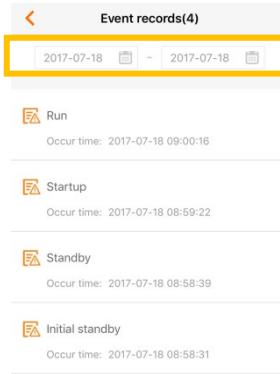

Fig. 10-13 Event records



If you need to check the event records within a certain period of time, please click the time selection bar on the top of the interface to select a certain period of time. The inverter can at most record the latest 100 events.

10.7 More

Click the “More” icon from the navigation bar to check more info as shown in Fig. 10-14. You can read and set the inverter parameters, download the logs and upgrade the firmware from the “More” interface.

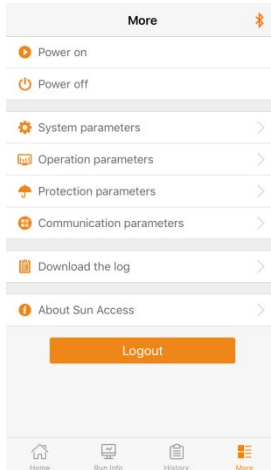

Fig. 10-14 More

10.7.1 Power On/Power Off

Click "Power on"/"Power off" and click "Confirm" in the dialog box popped out to start or stop the inverter as shown in Fig. 10-15.

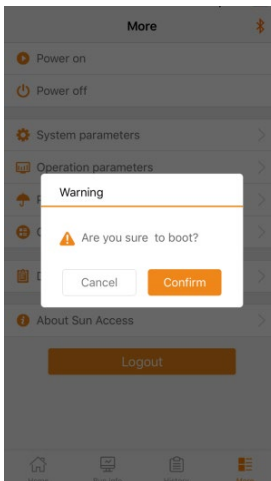

Fig. 10-15 Power on

10.7.2 System Parameters

Click the “System parameters” to check the system parameter info and set the related parameters as shown in Fig. 10-16.

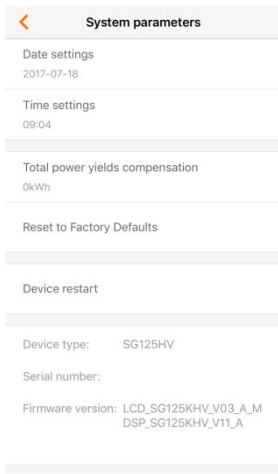

Fig. 10-16 System parameter

Tab. 10-5 Explanation of system parameters

Parameter	Description
Date Setting	Time deviation between the time on the inverter and the local time of the installation site may cause data logging failure. Please adjust inverter time according to the local time.
Time Setting	
Total power yields compensation	If the accumulative value “E-total” in the inverter is different from the value in the external metering device, you should adjust energy by “Total power yields compensation” setting.
Reset to Factory Defaults	All history information will be unrecoverable cleared and all parameters will return to the default value except the protective parameters and time once the “Reset to Factory Defaults” operation is performed.
Device restart	Restart the device.
Device information	You can check: Device type, Serial number and Firmware version

10.7.3 Operation Parameters

Click the "Operation parameters" to check the operation parameters and set the related parameters as shown in Fig. 10-17

The operation parameters include the active & reactive power parameters.

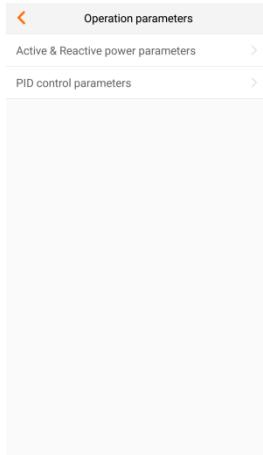

Fig. 10-17 Operation parameters

Active & reactive power parameters

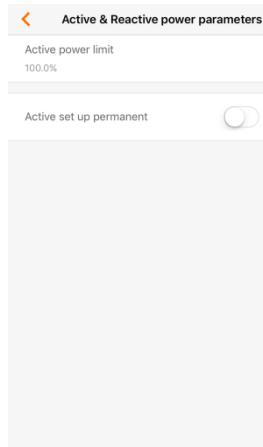
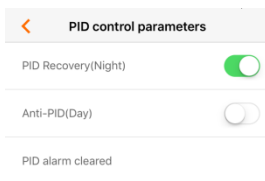

Fig. 10-18 Active & reactive power parameters

Tab. 10-6 Description of Active & reactive power parameters

Parameter	Description	Default	Range
Active power limit	Inverter active power limitation	100.0%	0~100%
Active set up permanent	If set to "ON", after the power limit is modified, the change will be saved after the inverter restarts after power failure. If set to "OFF", after the power limit is modified, the change will not be saved after the inverter power off and restarted.	[OFF]	[ON]/ [OFF]

PID control parameter

**Fig. 10-19** PID control parameters

Parameter	Description
PID Recovery(Night)	Set enabling/disabling of the PID night recovery function. PID night recovery functions between 22:00 pm and 5:00 am by default.

Parameter	Description
Anti-PID(Day)	Set enabling/disabling of the PID day protection function. PID day protection functions only when the inverter is in grid-connected state.
PID alarm clearing	If ISO impedance abnormality or PID function exception is detected during running of the PID function, the inverter reports a PID false alarm and reminds the user to take corresponding measures. After processing, the alarm information can be cleared via the function.



- After the PID Recovery(Night) / Anti-PID(Day) function is enabled, the fault indicator on the inverter main panel turns green.
- The PID night recovery function and the PID day protection function cannot be enabled at the same time.

10.7.4 Protection Parameters

Click the "Protection parameter" to check the protection parameter and set the related parameters as shown in Fig. 10-20.



User can only check the parameter in this interface. The default values of the protection parameters have been preset as per grid code of corresponding countries.

To set the protection parameter, please contact Sungrow to acquire advanced password.

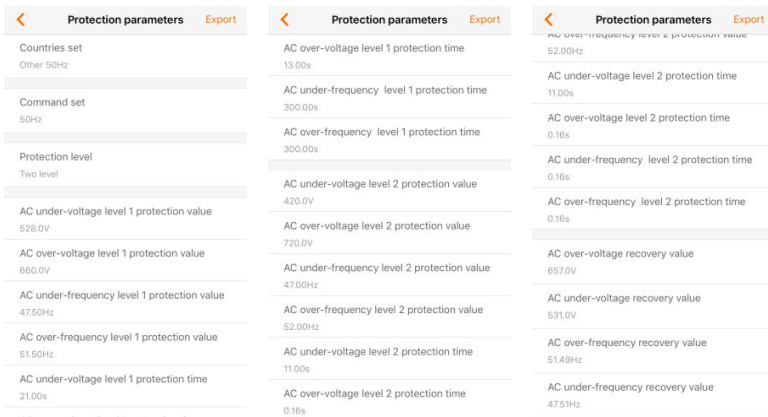

Fig. 10-20 Protection parameter

For convenient protection parameter setting, the protection parameters are preset for certain countries. After country setting, select the protection stage as single or multiple and then set the corresponding protection parameter.

Tab. 10-7 Single-stage Protection Parameters Explanation

Parameter	Range	Default
AC under-voltage single-stage protection value	60V-600V	528V
AC over-voltage single-stage protection value	477V-826V	660V
AC under-frequency single-stage protection value	53.00Hz -59.90Hz	59.80Hz
AC over-frequency single-stage protection value	65.00Hz -62.00Hz	60.50Hz

Tab. 10-8 Multi-stage Protection Parameters Explanation

Parameter	Range	Default
AC under-voltage level 1 protection value	60V-600V	528V
AC over-voltage level 1 protection value	477V-826V	660V
AC under-frequency level 1 protection value	53.00Hz -59.90Hz	59.80Hz
AC over-frequency level 1 protection value	65.00Hz -62.00Hz	60.50Hz
AC under-voltage level 1 protection time	0s-600s	2s
AC over-voltage level 1 protection time	0s-600s	1s
AC under-frequency level 1 protection time	0s-600s	0.16s
AC over-frequency level 1 protection time	0s-600s	0.16s
AC under-voltage level 2 protection value	60V-600V	300V
AC over-voltage level 2 protection value	477V-826V	720V

Parameter	Range	Default
AC under-frequency level 2 protection value	53.00Hz -59.90Hz	57.00Hz
AC over-frequency level 2 protection value	65.00Hz -62.00Hz	60.50Hz
AC under-voltage level 2 protection time	0s-600s	0.16s
AC over-voltage level 2 protection time	0s-600s	0.16s
AC under-frequency level 2 protection time	0s-600s	0.16s
AC over-frequency level 2 protection time	0s-600s	0.16s
AC under-voltage level 3 protection value	477V-826V	720V
AC under-voltage level 3 protection time	0s-600s	0.16s

Proceed to set the protection recovery value after setting the single-stage/multi-stage protection stage.

Tab. 10-9 Description of protection recovery parameters

Parameter	Explanation	Range	Default
Vmax-recover	Max. protection recovery voltage	600.0V- 738.0V	657V
Vmin-recover	Min. protection recovery voltage	60.0V- 600.0V	531V
Fmax-recover	Max. protection recovery frequency	60.00Hz-65.00Hz	60.49Hz
Fmin-recover	Min. protection recovery frequency	50.00Hz-60.00Hz	59.81Hz

* Please follow the rules below to set parameters:

AC under-voltage level 1 protection value \geq AC under-voltage level 2 protection value \geq AC under-voltage level 3 protection value;

AC over-voltage level 1 protection value \leq AC over-voltage level 2 protection value \leq AC over-voltage level 3 protection value;

AC under-frequency level 1 protection value \geq AC under-frequency level 2 protection value \geq AC under-frequency level 3 protection value;

AC over-frequency level 1 protection value \leq AC over-frequency level 2 protection value \leq AC over-frequency level 3 protection value;

AC under-voltage level 1 protection time \geq AC under-voltage level 2 protection time \geq AC under-voltage level 3 protection time;

AC over-voltage level 1 protection time \geq AC over-voltage level 2 protection time

\geq AC over-voltage level 3 protection time;

AC under-frequency level 1 protection time \geq AC under-frequency level 2 protection time \geq AC under-frequency level 3 protection time;

AC over-frequency level 1 protection time \geq AC over-frequency level 2 protection time \geq AC over-frequency level 3 protection time;

AC under-voltage recovery value \geq AC under-voltage level 1 protection value + 3V;

AC over-voltage recovery value \leq AC over-voltage level 1 protection value - 3V;

AC under-frequency recovery value \geq AC under-frequency level 1 protection value + 0.01Hz;

AC over-frequency recovery value \leq AC over-frequency level 1 protection value - 0.01Hz.

NOTICE

- **The range and default value in the table above is indicative only.**
- **The protection parameter varies in different countries. Please refer to**
- **the standards of each country for details.**

10.7.5 Communication Parameters

Click the "Communication parameters" to check the communication parameters and set the related parameters as shown in Fig. 10-21.

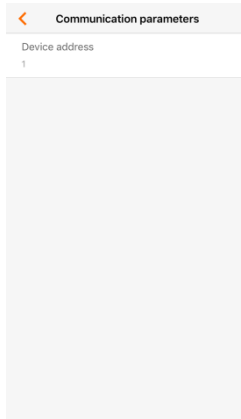

Fig. 10-21 Communication parameters

Tab. 10-10 Explanation of communication parameters

Parameter	Description
Device address	Range: 1-247

10.7.6 Download the Log

Click the “Download the log” to check the log download interface and download the logs as shown in Fig. 10-22.

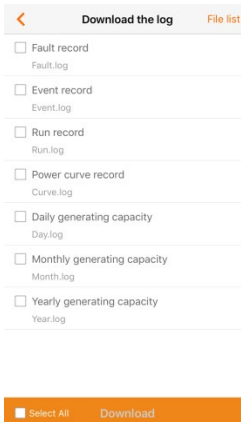

Fig. 10-22 Download the logs

10.7.7 About SunAccess

Click the "About SunAccess" to check the about the interface as shown in Fig. 10-23.

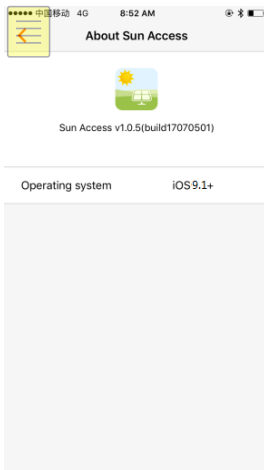

Fig. 10-23 About SunAccess

11 Appendix

11.1 Technical Data

Parameters	SG125HV	SG125HV-20
Input (DC)		
Max. PV input voltage	1500V	
Min.PV input voltage/Startup input voltage	860V/920V	
Nominal input voltage	1050V	
MPP voltage range	860-1450V	
MPP voltage range for nominal power	860-1250V	
No. of independent MPP inputs	1	
No. of DC inputs	1	
Max. PV input current	148A	
Max.DC Short-circuit current	240A	
Max. inverter backfeed current to the array	0A	
Output (AC)		
AC output power	125000 VA @ 50 °C	
Max. AC output current	120 A	
Nominal AC voltage	3 / PE, 600 V	
AC voltage range	480 – 690 V	
Nominal grid frequency / Grid frequency range	50 Hz / 45 – 55 Hz, 60 Hz / 55 – 65 Hz	
THD	< 3 % (at nominal power)	
DC current injection	< 0.5 % In	
Power factor at nominal power / Adjustable power factor	> 0.99 / 0.8 leading – 0.8 lagging	
Feed-in phases / Connection phases	3 / 3	
Efficiency		
Max. efficiency / Euro. efficiency / CEC efficiency	98.9 % / 98.7 % / 98.5 %	
Protection		
DC reverse connection	Yes	

Parameters	SG125HV	SG125HV-20
protection		
AC short-circuit protection	Yes	
Leakage current protection	Yes	
Grid monitoring	Yes	
DC switch / AC switch	Yes / Yes	
Anti-PID function	Optional	Yes
PID recovery function	Optional	Yes
Overvoltage protection	DC Type II / AC Type II	
Night SVG function	No	Yes
General Data		
Dimensions (W*H*D)	670*902*296 mm/26.4"*35.5"*11.7"	
Weight	76 kg/167.6 lb	
Isolation method	Transformerless	
Degree of protection	IP65/NEMA 4X	
Night power consumption	< 4 W	
Operating ambient temperature range	-25 to 60 °C (> 50 °C derating)/ -13 to 140 °F (> 122 °F derating)	
Allowable relative humidity range (non-condensing)	0 – 100 %	
Cooling method	Smart forced air cooling	
Max. operating altitude	4000 m (> 3000 m derating)/ 13123 ft (> 9843 ft derating)	
Display / Communication	LED, Bluetooth+APP / RS485	
DC connection type	OT or DT terminal (Max. 185mm ² /350 Kcmil)	
AC connection type	OT or DT terminal (Max. 185mm ² /350 Kcmil)	
Compliance	CE, IEC 62109-1/-2, IEC 61000-6-2/-4, IEC 61727, IEC 62116, IEC 61000-3-11/-12, UL 1741, UL 1741 SA, IEEE 1547, IEEE 1547.1, CSA C22.2 107.1-01 and California Rule 21	
Grid support	LVRT, HVRT, active & reactive power control and power ramp rate control	

11.2 Tightening Torques

Bolt location	Specification	Torque	
		Nm	ft-lb
Enclosure	M6	4.2-4.5	3.1~3.3

PC protection plate	M4	1.2-1.4	0.9~1.0
AC cable connection terminal	M10	34-40	25.1~29.5
AC ground terminal	M10	12-14	8.8~10.3
DC cable connection terminal	M10	34-40	25.1~29.5
DC ground terminal	M10 (Left)	12-14	8.8~10.3
	M6 (Right)	4.2-4.5	3.1~3.3
Second PE terminal	M6	4.2-4.5	3.1~3.3

11.3 Exclusion of Liability

The content of these documents is periodically checked and revised where necessary. Please call us or check our website www.sungrowpower.com for the latest information. No guarantee is made for the completeness of these documents. Please contact our company or distributors for the latest version.

Guarantee or liability claims for damages of any kind are excluded if they are caused

- Improper or inappropriate use or install of the product
- Install or operate the product in unintended environment
- Install or operate the product without observing relevant safety regulations in the deployment location
- Ignore the safety warnings or instructions contained in all documents relevant to the product
- Install or operate the product under incorrect safety or protection conditions
- Alter the product or supplied software without authority
- Product malfunctions due to operation attached or neighboring devices running out of the allowed limit values
- Unforeseen calamity or force majeure
- The use of supplied software produced by Sungrow Power Supply Co., Ltd.. is subject to the following conditions:
 - Sungrow Power Supply Co., Ltd. assumes no liability for direct or indirect damages arising from the use of SolarInfo software. This also applies to the provision or non-provision of support activities.
 - SolarInfo software used for commercial purposes is prohibited.

- Decompiling, decoding or destroying the original program, including SolarInfo software and the embedded software, is prohibited.

11.4 Contact Information

Should you have any question about this product, please contact us.

We need the following information to provide you the best assistance:

- Type of the inverter
- Serial number of the inverter
- Fault code/name
- Brief description of the problem

China (HQ)

SUNGROW POWER SUPPLY Co., Ltd
Hefei
+86 551 65327834
service@sungrowpower.com

Australia

SUNGROW Australia Group Pty. Ltd.
NSW
+61 2 9922 1522
service@sungrowpower.com.au

Brazil

SUNGROW Power do Brasil
Sao Paulo
+55 015 9 98197824
kaue.oliveira@sa.sungrowpower.com

France

SUNGROW France – Siege Social
Paris
+33 762899888
service.france@sungrow.co

Germany

SUNGROW Deutschland GmbH
München
+49 (0) 89 324914761
service.germany@sungrow.co

Greece

Service Partner – Survey Digital
+30 2106044212
service.greece@sungrow.co

Italy

SUNGROW Italy
Milano
+39 3391096413
service.italy@sungrow.co

Japan

SUNGROW Japan K.K.
Tokyo
+81 3 6262 9918
japanservice@jp.sungrowpower.com

Korea

SUNGROW POWER KOREA LIMITED
 Seoul
 +82 70 7719 1889
 service@kr.sungrowpower.com

Malaysia

SUNGROW SEA
 Selangor Darul Ehsan
 +60 19 897 3360
 service@my.sungrowpower.com

Philippines

SUNGROW POWER SUPPLY Co., Ltd
 Mandaluyong City
 +63 9173022769
 service@ph.sungrowpower.com

Thailand

SUNGROW Power (Hong Kong) Co.,
 Ltd.
 Bangkok
 +66 891246053
 service@th.sungrowpower.com

Spain

SUNGROW Ibérica S.L.U.
 Navarra
 service.spain@sungrow.co

Romania

Service Partner - Elerex
 +40 241762250
 service.romania@sungrow.co

Turkey

SUNGROW Deutschland GmbH Turkey
 Istanbul Representative Bureau
 Istanbul
 +90 212 731 8883
 service.turkey@sungrow.co

UK

SUNGROW Power UK Ltd.
 Milton Keynes
 +44 (0) 0908 414127
 service.uk@sungrow.co

U.S.A, Mexico

SUNGROW USA
 Phoenix
 +1 833 747 6937
 techsupport@sungrow-na.com